

**YEAR 1**

**LEARNING**

**- FROM -**

**• HOME •**

 **teachstarter**

## ABOUT THIS PACK

This teaching resource pack has been handpicked by the Teach Starter team to include a range of resources that can be completed at home by children with the assistance of their parents or guardians.

The pack includes resources covering the key learning areas of English, Maths and Science, along with some additional craft and mindfulness activities - all for free!

In the rare event of a school closure or if a student needs to work remotely, this pack can be sent home with students or passed on directly to parents and guardians digitally to allow for students to complete the work with minimal preparation and supervision.

The pack is designed to allow for non-teachers to understand and implement the activities in a home environment without requiring additional resources found in a classroom. The pack can be completed digitally on a tablet/iPad or with pen and paper when printed.

### For Teachers

#### Can I share this pack with parents, students and other teachers?

Of course! This pack has been created specifically for this purpose. Please feel free to share this pack digitally with your students, their parents or guardians, or other teachers.

You can share by copying the URL in the address bar of your browser, or simply clicking on the envelope icon above to send to an email address. You can also download the pack, and email the PDF document itself.

Please feel free to bundle this pack with your own home learning activities to extend or reinforce particular concepts for your students. You may also like to add specific activities such as reading, outdoor play, fine motor skills etc.

### For Parents

#### How can I teach my child if their school closes?

By downloading this free resource pack, you will be equipped with a wide range of activities to share with your child while their school is closed.

We have ensured that this pack can be delivered by non-teachers by providing a helpful table of contents and activity overviews. All activities are age-appropriate and most will relate to work that your child has experienced in the classroom.

The activities can be completed in any order and have been selected to allow parents and guardians to easily implement them.

# YEAR 1

## CONTENTS

### English

#### *Editing*

##### **20 x Editing Task Cards**

Students are required to edit the pieces of text. Each piece of text provides the number of errors and any punctuation that needs to be added. These could be used as a literacy warm-up activity each morning.

#### *Spelling*

##### **20 x Spelling Words - Activity Grid**

Use these spelling activity grids when working on different sounds. If students have been provided with a personalised spelling list, use the activities provided on the grid to work with their words. If they have not been provided with a spelling list, select 2 or 3 of these sheets to work with. Consider doing a spelling test before selecting the sheet to see which words they need to work on.

##### **Word Work Grid - V1**

Students use this grid of 15 activities when working with their spelling words. The activities can be completed using the provided templates or in a workbook.

#### *Reading*

##### **2 x Comprehension Worksheets - Superfoods What's for Lunch? and Search-A-Rooney**

Students are required to read the text and answer the questions either in a workbook or using the sheet provided.

##### **My Book Report Template**

Students can pick a recent text they have read and then complete this Book Report template. Three different versions have been provided.

#### *Grammar*

##### **Jack and the Beanstalk - Capital Letter and Full Stop Scavenger Hunt Worksheet**

Read Jack and The Beanstalk. Re-read the text, referring to the punctuation in the text and then ask students to complete the worksheets.

##### **Nouns, Verbs and Adjectives - Sorting Task**

Students cut out each word and paste them into the table under the correct heading.

## *Persuasive Writing*

### **For and Against - Worksheet**

Students cut out the 'for' and 'against' statements and paste them in the correct column of the table provided.

## *Narrative Writing*

### **Story Map**

After reading a story book together, instruct students to fill in the provided Story Map. This could be completed using several different books. Students can also use this template to plan and write a narrative text of their own.

### **Story Spine Porcupine - Template**

Use this writing template to help students plan and order their idea's structure and create a basic 'story spine' before writing their narrative stories.

## *Informative Writing*

### **Informative Writing - Animal Research Task**

An 8 page booklet for students to record facts about animals when learning to write informative texts.

## **Maths**

### *Operations*

#### **Hundreds Board - Mystery Picture - Number Task Cards**

This teaching resource requires students to colour in number squares on a hundreds board to reveal a mystery picture. Students can draw up their own grid in a workbook or have several copies of the hundreds grid to complete all the pictures provided. A copy with the numbers on the hundreds board and a copy without the numbers has been provided. Use the version that your student requires.

#### **Maths Word Problem Cards - Addition and Subtraction**

Students can complete these word problem cards in their workbook.

### *Maths Activities*

#### **Patterns Maths Investigation - Bands of Friendship**

A mathematics investigation involving patterns, embedded in a real-world context. This open-ended mathematics investigation has been designed to deepen students' understanding of patterns.

#### **Pandora's Party Palace Maths Activity**

Students use these sixteen problem-solving task cards in association with the stimulus to work with money in a real-world context.



## Science

### **How Can We Help Our Planet? - Mini Booklet**

Students colour the pictures and complete the sentences. Once each section is complete, students cut along the dotted lines and staple their mini book together.

### **Spacecraft Design Task**

Students design, plan and make a spacecraft. A list of suggested materials are on the worksheet, but students can use anything they have available to them.

## Other

### *Mindfulness*

### **Mindfulness Colouring Sheet - Stegosaurus**

Students use this sheet when they require a brain break or at the end of the day.

## 1 Tom's Broken Leg

my brother tom broke his  
leg playing soccer He haz  
a red crutch to help hiim  
walk.

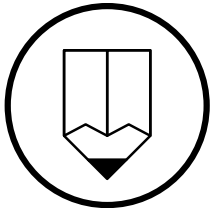

Find 2 spelling mistakes.  
Add 2 capital letters and 1 full stop.

## 2 Windy Day

it was a really windy day  
on Sondag. kate and ben  
tok their kite to the park  
to fly it

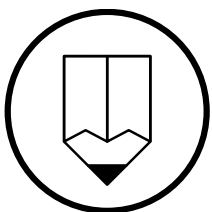

Find 2 spelling mistakes.  
Add 3 capital letters and 1 full stop.

### 3 A Rainy Day

the sky started to tern  
grey. Rain started to fall  
on my head. i poot up my  
favourite umbrella

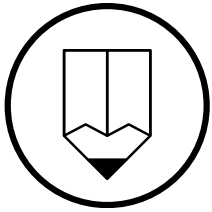

Find 2 spelling mistakes.  
Add 2 capital letters and 1 full stop.

### 4 Show and Tell

for show and tell tooday  
Bill bought his cat. his  
name is called Snowflake.  
Snowflake likes big huggs

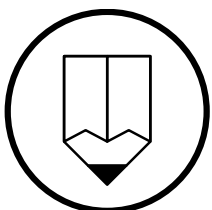

Find 2 spelling mistakes.  
Add 2 capital letters and 1 full stop.

## 5 Rob the Robot

rob the robot lieks the  
colour green. He has long  
slinky blu arms. he has a  
red button on his head

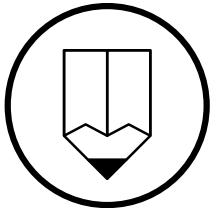

Find 2 spelling mistakes.  
Add 2 capital letters and 1 full stop.

## 6 Map of the World

jane was looking at a map  
of teh world. she culd see  
all the water and land

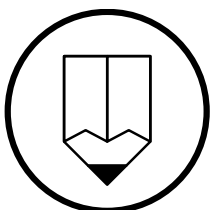

Find 2 spelling mistakes.  
Add 2 capital letters and 1 full stop.

## 7 Jumping in Puddles

jill wore her raine boots  
today. there wer lots of  
muddy puddles to jump  
in

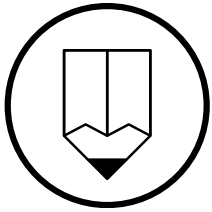

Find 2 spelling mistakes.  
Add 2 capital letters and 1 full stop.

## 8 Slimy Frogs

frogs do not drink water  
like we do. They get watar  
through their skin. this is  
whyy frog skin feels slimy

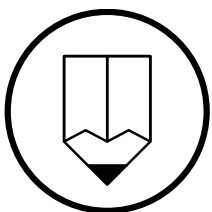

Find 2 spelling mistakes.  
Add 2 capital letters and 1 full stop.

## 9 Wags the Dog

wags the dog has run  
away. Do you know  
where wags has goen

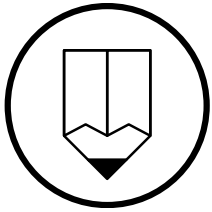

Find 2 spelling mistakes.  
Add 2 capital letters and 1 question mark.

## 10 Hot, Hot, Hot!

the sun is really hott.  
What do i need to stay  
sayfe from the sun

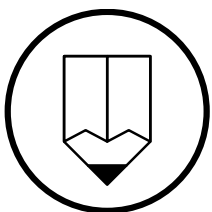

Find 2 spelling mistakes.  
Add 2 capital letters and 1 question mark.

## 11 What's Hiding?

there is something hiding  
under that rock. Do you  
know wat it is

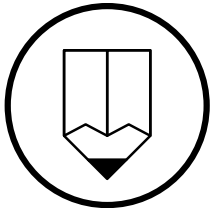

Find 2 spelling mistakes.  
Add 1 capital letter and 1 question mark.

## 12 What Am I?

i have a really loong neck  
and i like to eat leaves.  
What do you thinnk I  
might be

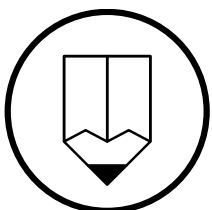

Find 2 spelling mistakes.  
Add 2 capital letters and 1 question mark.

13

## Race Day

i crossd the finish line. i  
was so happi! I came first

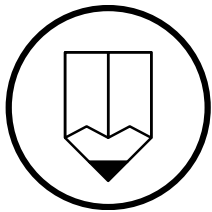

Find 2 spelling mistakes.  
Add 2 capital letters and 1 exclamation mark.

 teachstarter

14

## My Hairbrush

my sister was using mi  
hairbrush. i was sow  
angry

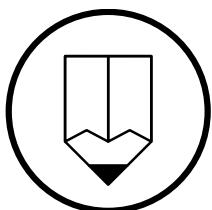

Find 2 spelling mistakes.  
Add 2 capital letters and 1 exclamation mark.

 teachstarter



## 15 Pop!

bang! i popped thee  
balloon using my finger. It  
gave my Mam a fright

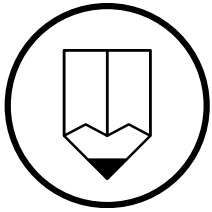

Find 2 spelling mistakes.  
Add 2 capital letters and 1 exclamation mark.

## 16 Bouncy Ball

help! My bal has bounced  
away and i can't finde it.  
Can you help me

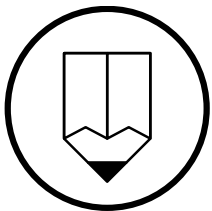

Find 2 spelling mistakes.  
Add 2 capital letters and 1 question mark.

## 17 The Cat and the Rat

the cat was sleeping on  
the mat. a fat rat caem  
and sat next to the  
seeping cat

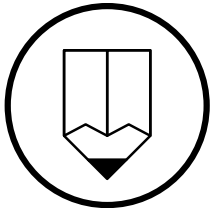

Find 2 spelling mistakes.  
Add 2 capital letters and 1 full stop.

## 18 The Vet

we took my pet to the  
vet. My vett has not met  
my pet yet. i hoep my pet  
likes the vet

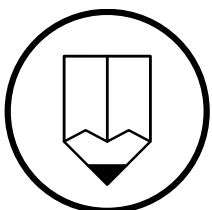

Find 2 spelling mistakes.  
Add 2 capital letters and 1 full stop.

## 19 Fun in the Sun

on the weekand we had  
some fun in the sun. We  
went for a run and aet a  
yummy bun

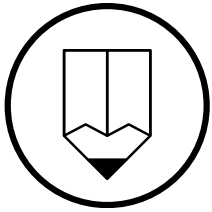

Find 2 spelling mistakes.  
Add 1 capital letter and 1 full stop.

## 20 Ted the Dog

ted the dog was reddy  
to be fed. His food bowle  
was next to his bed in the  
red shed

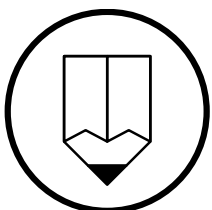

Find 2 spelling mistakes.  
Add 1 capital letter and 1 full stop.

# Activity Grid

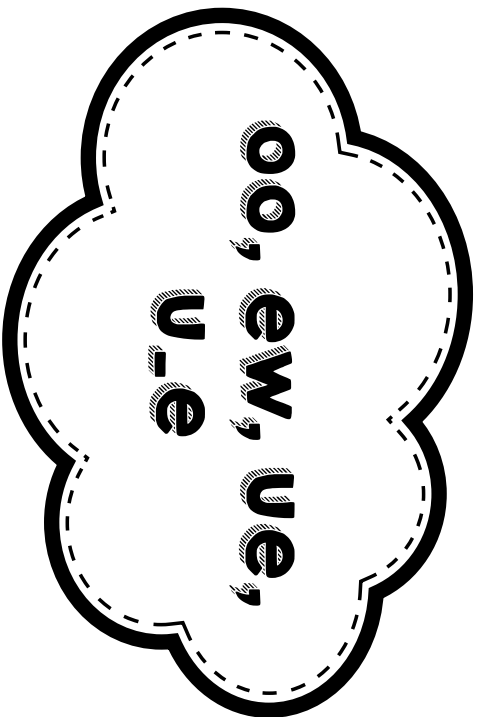

## Spelling Words

1. too
2. boot
3. screw
4. few
5. glue
6. blue
7. June
8. cube
9. room
10. soon

## Extension

1. rescue
2. Tuesday
3. goose
4. statue
5. choose

Sort your spelling words into their phoneme groups (oo,ew,ue,u-e).	Use magazines or newspapers to cut out the letters you need to spell the spelling words.
Jumble up the letters of your spelling words. Give them to a partner to unjumble.	Use five of your spelling words in five sentences.
Write out each of your spelling words using dots.	Use glue to write out each spelling word. Sprinkle glitter over the glue.
Group your spelling words according to the number of syllables.	Use five of your spelling words in five sentences.
Write out your spelling words in rainbow colours.	Build your spelling words using Lego or blocks.

# Activity Grid

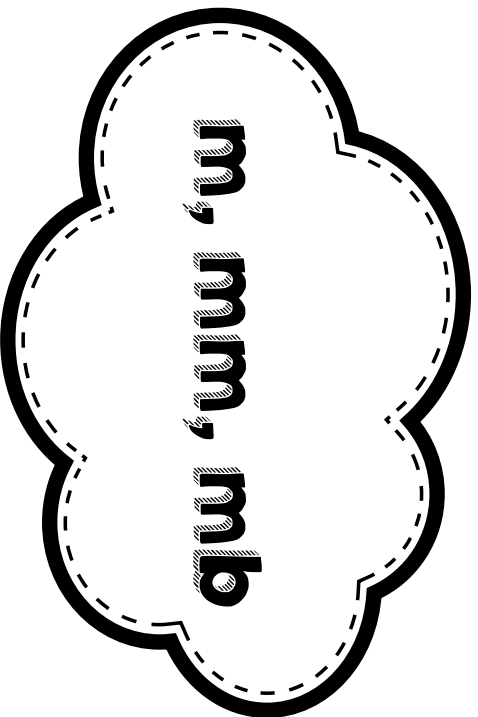

## Spelling Words

1. moon
2. camp
3. mango
4. hammer
5. summer
6. thumb
7. comb
8. lamb
9. many
10. smile

## Extension

1. animal
2. comment
3. number
4. material
5. million

Sort the words into their phoneme groups (m,mm,mb).	Write as many words as you can that rhyme with each of your spelling words.
Type your spelling words on a computer.	Put your spelling words in alphabetical order.
Using a container of water and a paintbrush, paint each of your spelling words on some concrete.	Draw one shape for each word. Write your spelling words inside each of the shapes.
Using grid paper, write out your spelling words. Put each sound in one box. Like this: Ch-ee-se	Use chalk to write out your spelling words on concrete.
Using the spelling words, write the vowels in blue and the consonants in red.	Write out your spelling words and circle the phoneme you are learning.

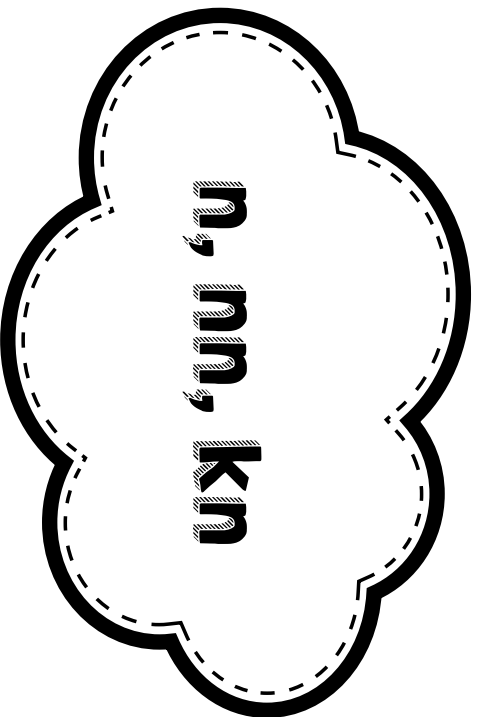

# Activity Grid

Sort your spelling words into their phoneme groups (n,nn,kn).

Use glue to write out each spelling word. Sprinkle glitter over the glue.

Use magazines or newspaper to cut out the letters you need to spell your spelling words.

Build your spelling words using Lego or blocks.

Find words in books that match your weekly phoneme.

Write out your spelling words in rainbow colours.

Write out each of your spelling words using dots.

Group your spelling words according to the number of syllables.

Draw a picture and hide your spelling words in the picture.

Use five of your spelling words in five sentences.

## Spelling Words

1. run
2. line
3. night
4. winner
5. dinner
6. knife
7. knee
8. spoon
9. know
10. nose

## Extension

1. normal
2. grinning
3. knives
4. ninety
5. November

# Activity Grid

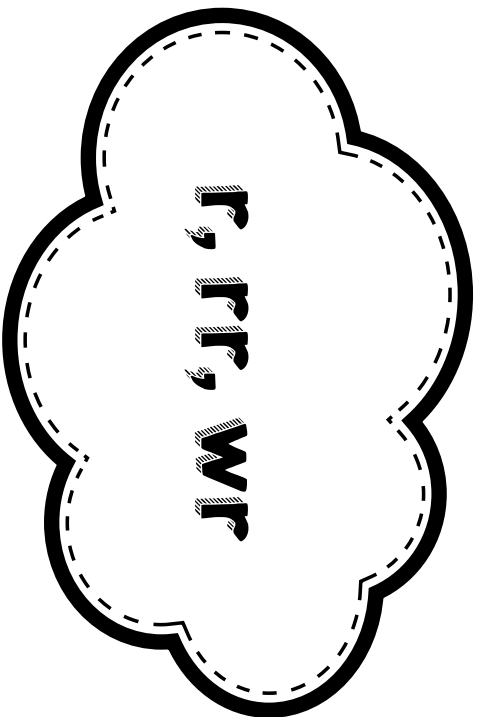

## Spelling Words

1. room
2. read
3. rain
4. carry
5. sorry
6. carrot
7. write
8. wrap
9. wrist
10. river

## Extension

1. afraid
2. frozen
3. wreck
4. wrong
5. during

Sort your spelling words into their phoneme groups (r,rr,wr).

Put your spelling words in alphabetical order.

Type your spelling words on a computer.

Write as many words as you can that rhyme with each of your spelling words.

Write out your spelling words using a white crayon. Once all words have been written, use watercolours and paint to make hidden words appear.

Use pipe cleaners to write out your spelling words.

Using your spelling words, write the vowels in blue and the consonants in red.

Draw one shape for each word. Write your spelling words inside each of the shapes.

Using grid paper, write out your spelling words. Put each sound in one box. Like this: Ch-ee-se

Draw a picture and hide your spelling words in the picture.

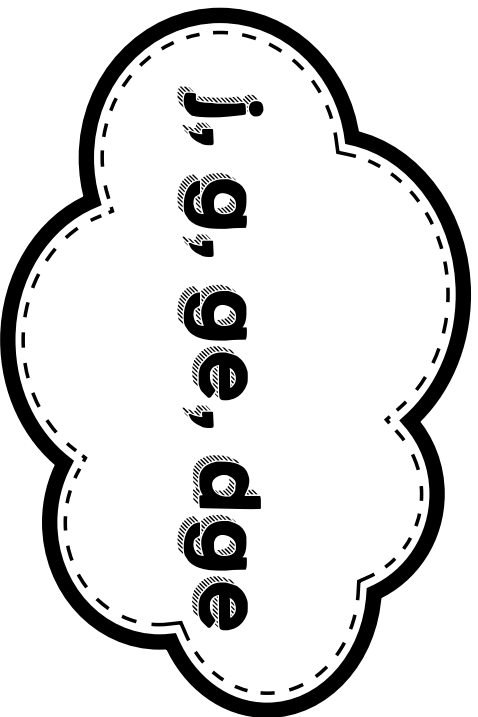

## Spelling Words

1. jelly
2. jump
3. cage
4. page
5. germ
6. large
7. orange
8. change
9. fridge
10. badge

## Extension

1. giraffe
2. bridge
3. danger
4. juice
5. gigantic

## Activity Grid

Sort your spelling words into their phoneme groups (j,g,ge,dge).	Use glue to write out each spelling words. Sprinkle glitter over the glue.
Use magazines or newspapers to cut out the letters you need to spell your spelling words.	Write out your spelling words in rainbow colours.
Find words in books that match your weekly phoneme.	Build your spelling words using Lego or blocks.
Write out each of your spelling words using dots.	Use five of your spelling words in five sentences.
Group your spelling words according to the number of syllables.	Using your spelling words, write the vowels in blue and the consonants in red.



# Activity Grid

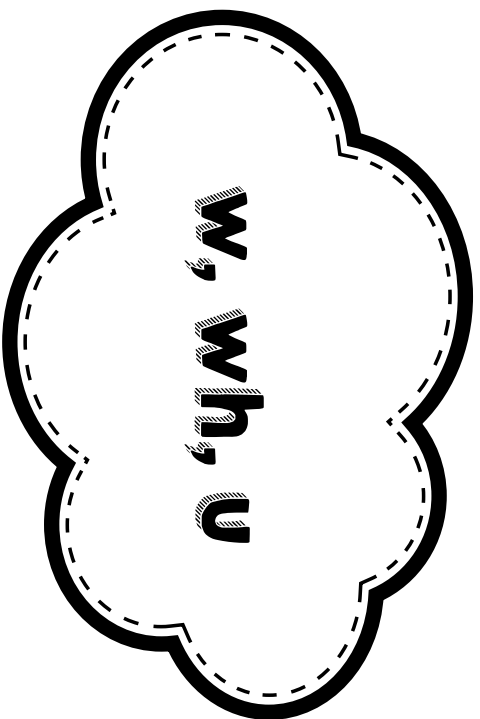

## Spelling Words

1. swim
2. word
3. web
4. white
5. whale
6. quick
7. quiet
8. winter
9. warm
10. worm

## Extension

1. whisper
2. weather
3. question
4. awake
5. welcome

Sort your spelling words into their phoneme groups (w,wh,u).	Using grid paper, write out your spelling words. Put each sound in one box. Like this: Ch-ee-se
Write out your spelling words. Circle the phoneme you are learning.	Put your spelling words in alphabetical order.
Using your spelling words, write the vowels in blue and the consonants in red.	Draw one shape for each word. Write your spelling words inside each of the shapes.
Use magazines or newspapers to cut out the letters you need to spell your spelling words.	Draw a picture and hide your spelling words in the picture.
Using a container of water and a paintbrush, paint each of your spelling words on some concrete.	Use chalk to write out your spelling words on cement.

# Activity Grid

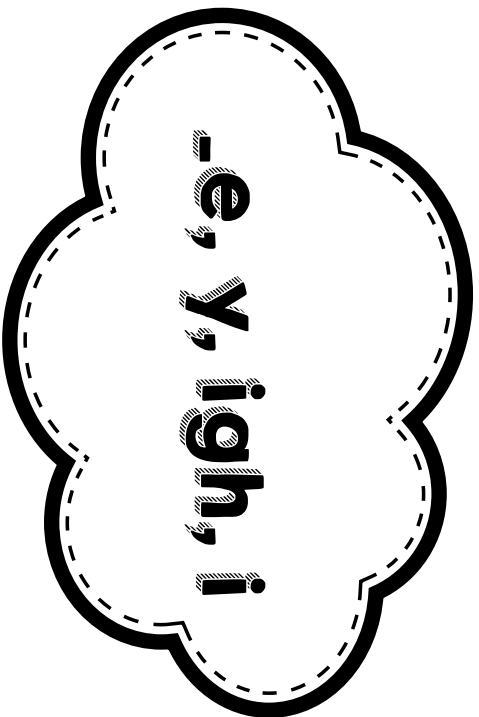

## Spelling Words

1. line
2. ride
3. cry
4. fly
5. light
6. night
7. kind
8. spider
9. dry
10. ice

## Extension

1. invite
2. climb
3. arrive
4. bright
5. surprise

Sort your spelling words into their phoneme groups (_e,y,igh,i).	Write out your words in rainbow colours.
Group your spelling words according to the number of syllables.	Draw a picture and hide your spelling words in the picture.
Write out each of your spelling words using dots.	Jumble up the letters of your spelling words. Give them to a partner to unjumble.
Find words in books that match your weekly phoneme. Write a list of these words.	Build your spelling words using Lego or blocks.
Use glue to write out each spelling word. Sprinkle glitter over the glue.	Use five of your spelling words in five sentences.

# Activity Grid

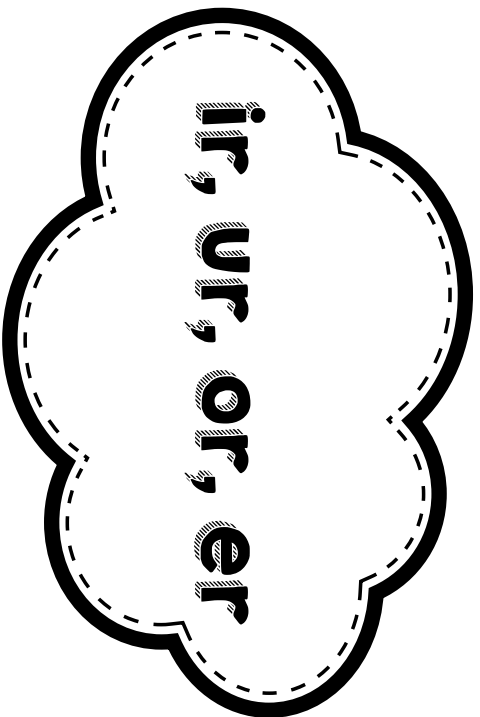

## Spelling Words

1. girl
2. bird
3. turn
4. nurse
5. worm
6. fern
7. work
8. third
9. herd
10. burn

## Extension

1. worse
2. Thursday
3. surface
4. learn
5. journey

Sort you spelling words into their phoneme groups (ir,ur,or,er).

Use five of your spelling words in five sentences.

Type your spelling words on a computer.

Use magazines or newspaper to cut out the letters you need to spell your spelling words.

Using a container of water and a paintbrush, paint each of your spelling words on some concrete.

Using your spelling words, write the vowels in blue and the consonants in red.

Using grid paper, write out your spelling words. Put each sound in one box. Like this: Ch-ee-se

Put your spelling words in alphabetical order.

Write out your spelling words. Circle the phoneme you are learning.

Draw one shape for each word. Write your spelling words inside each of the shapes.

# Activity Grid

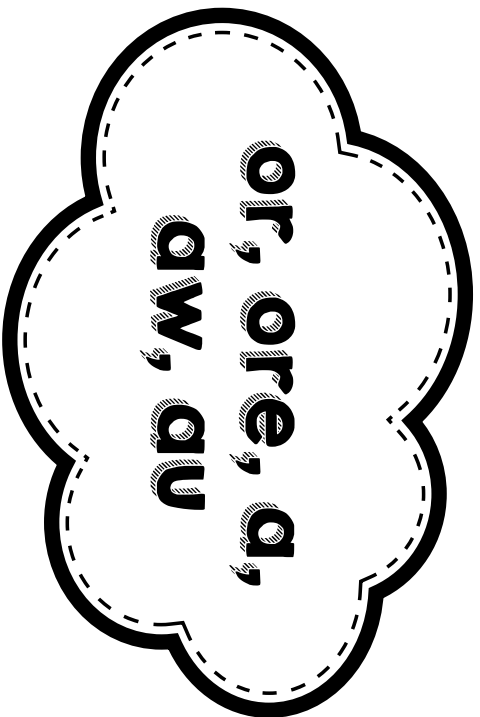

## Spelling Words

1. horse
2. born
3. more
4. core
5. ball
6. walk
7. paw
8. draw
9. sauce
10. caught

## Extension

1. almost
2. August
3. corner
4. naughty
5. order

Sort your spelling words into their phoneme groups (or,ore,a,aw,au).	Write a silly sentence using as many of your spelling words as possible.
Use chalk to write out your spelling words on concrete.	Group your spelling words according to the number of syllables.
Write out each of your spelling words using dots.	Build your spelling words using Lego or blocks.
Write out your spelling words in rainbow colours.	Jumble up the letters of your spelling words. Give them to a partner to unjumble.
Use glue to write out each spelling word. Sprinkle glitter over the glue.	Find words in books that match your weekly phoneme. Write a list of these words.

# Activity Grid

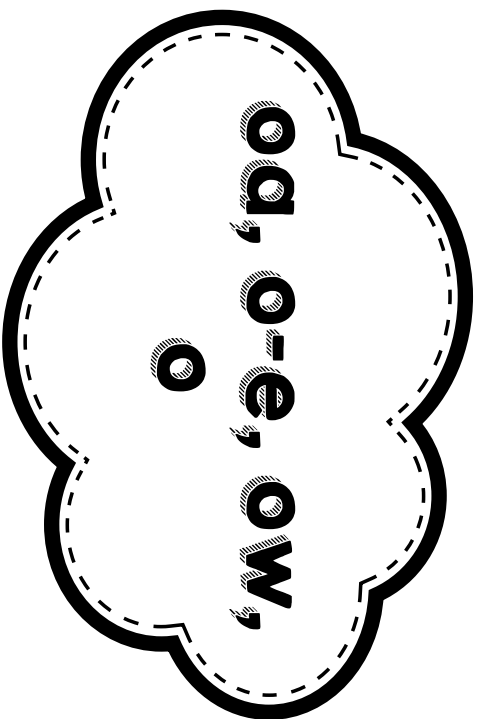

## Spelling Words

1. road
2. boat
3. stone
4. soap
5. cone
6. grow
7. slow
8. throw
9. over
10. only

## Extension

1. window
2. narrow
3. ocean
4. known
5. lonely

Sort your spelling words into their phoneme groups (oa,o-e,ow,u).	Use magazines or newspapers to cut out the letters you need to spell your spelling words.
Write as many words as you can that rhyme with each of your spelling words.	Type your spelling words on a computer.
Using a container of water and a paintbrush, paint each of your spelling words on some concrete.	Use five of your spelling words in five sentences.
Using grid paper, write out your spelling words. Put each sound in one box. Like this: Ch-ee-se	Put your spelling words in alphabetical order.
Using your spelling words, write the vowels in blue and the consonants in red.	Draw one shape for each word. Write your spelling words inside each of the shapes.

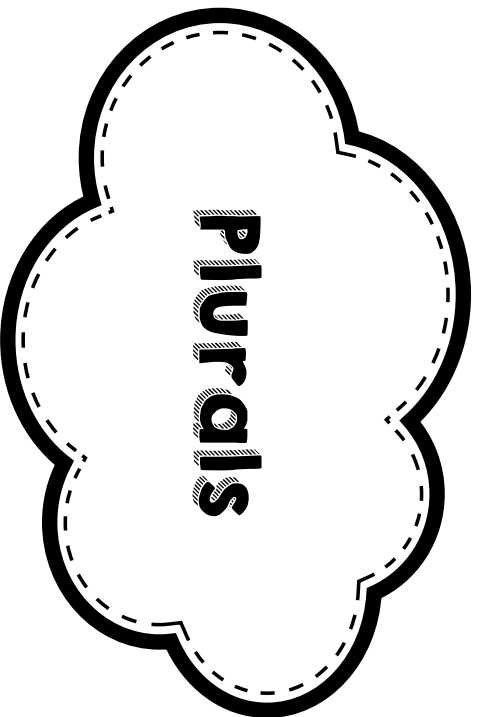

## Spelling Words

1. boxes
2. glasses
3. wishes
4. dresses
5. lunches
6. girls
7. months
8. plants
9. chairs
10. trains

## Extension

1. babies
2. families
3. pieces
4. puppies
5. stitches

## Activity Grid

Change the plurals back to singular words.	Put five of your spelling words in five sentences.
Using a container of water and a paintbrush, paint each of your spelling words on some concrete.	Write out your spelling words. Circle the letters that make these words plural.
Jumble up the letters of your spelling words. Give them to a partner to unjumble.	Write out your spelling words in rainbow colours.
Use magazines or newspaper to cut out the letters you need to spell your spelling words.	Group your spelling words according to the number of syllables.
Use glue to write out each spelling word. Sprinkle glitter over the glue.	Write out your spelling words and draw matching pictures on flash cards. Play a game of memory or snap with a partner.

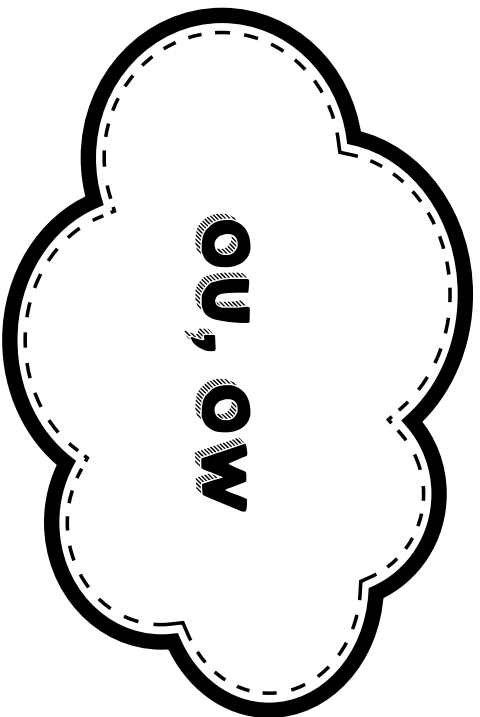

## Spelling Words

1. cow
2. down
3. flower
4. brown
5. mouse
6. house
7. count
8. loud
9. mouth
10. town

## Extension

1. bounce
2. downstairs
3. ourselves
4. frown
5. flour

## Activity Grid

Sort your spelling words into their phoneme groups (ou,ow).	Type your spelling words on a computer.
Group your spelling words according to the number of syllables.	Put your spelling words in alphabetical order.
Using your spelling words, write the vowels in blue and the consonants in red.	Draw one shape for each word. Write your spelling words inside each of the shapes.
Use magazines or newspaper to cut out the letters you need to spell your spelling words.	Write as many words as you can that rhyme with each of your spelling words.
Using grid paper, write out your spelling words. Put each sound in one box. Like this: Ch-ee-se	Use five of your spelling words in five sentences.

# Activity Grid

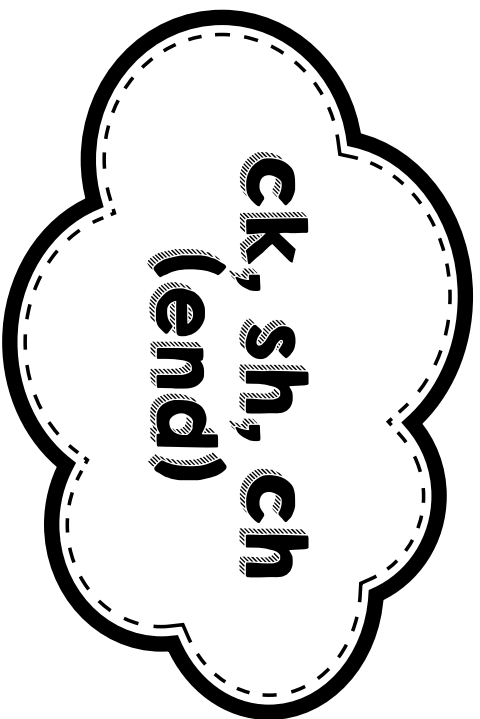

## Spelling Words

1. rock
2. duck
3. wash
4. rich
5. bunch
6. dish
7. fish
8. pick
9. lunch
10. touch

## Extension

1. rubbish
2. knock
3. beach
4. starfish
5. sandwich

Sort your spelling words into their digraph groups (ck,sh,ch).

Use glue to write each spelling word. Sprinkle glitter over the glue.

Write out your spelling words. Circle the digraphs in each word.

Put five of your spelling words in five sentences.

Using a container of water and a paintbrush, paint each of your spelling words on some concrete.

Write out your spelling words in rainbow colours.

Search through books to find your spelling words. Use tally marks to record how many times you find each word.

Build your spelling words using Lego or blocks.

Write out each of your spelling words using dots.

Put letter cards on the floor. Using a flyswatter, swat the letters in the order to spell words.



# Activity Grid

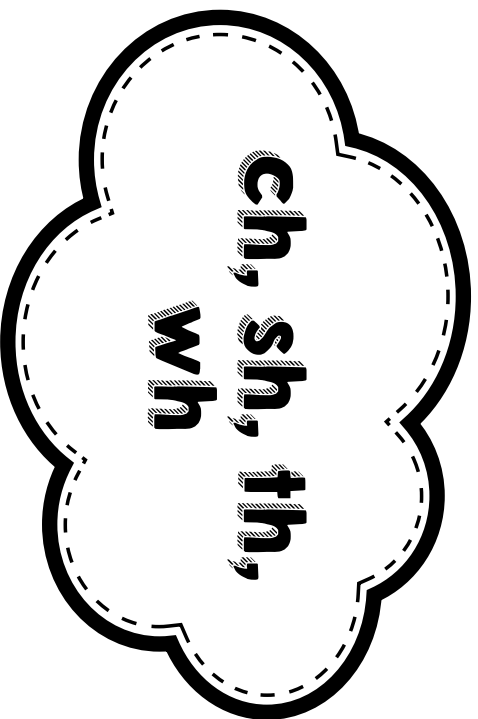

## Spelling Words

1. shark
2. thumb
3. chair
4. whale
5. chase
6. shell
7. three
8. wheel
9. shady
10. crew

## Extension

1. shallow
2. thunder
3. chicken
4. whistle
5. champion

Sort your spelling words into their diagraph groups (ch,sh,th,wh).	Put your spelling words in alphabetical order.
Type your spelling words on a computer.	Use five of your spelling words in five sentences.
Use magazines or newspaper to cut out the letters you need to spell your spelling words.	Write as many words as you can that rhyme with each of your spelling words.
Using your spelling words, write the vowels in blue and the consonants in red.	Draw one shape for each word. Write your spelling words inside each of the shapes.
Write out your spelling words. Circle the diagraphs in each word.	Draw a picture and hide your spelling words in the picture.

# Activity Grid

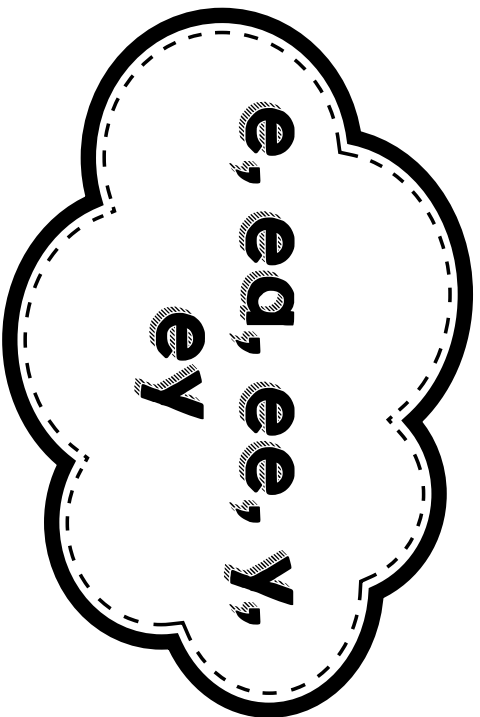

## Spelling Words

1. bee
2. week
3. me
4. meat
5. clean
6. beach
7. early
8. keep
9. key
10. any

## Extension

1. library
2. asleep
3. meeting
4. busy
5. ugly

Sort your spelling words into their phoneme groups (e,ea,ee,y,ey).	Use glue to write out each spelling word. Sprinkle glitter over the glue.
Jumble up the letters of your spelling words. Give them to a partner to unjumble.	Write out your spelling words in rainbow colours.
Using a container of water and a paintbrush, paint each of your spelling words on some concrete.	Build your spelling words using Lego or blocks.
Write out each of your spelling words using dots.	Write out your spelling words. Circle the sound you are learning about.
Count the number of letters in each spelling word. Write them in order from shortest to longest.	Write as many words as you can that rhyme with each of your spelling words.

# Activity Grid

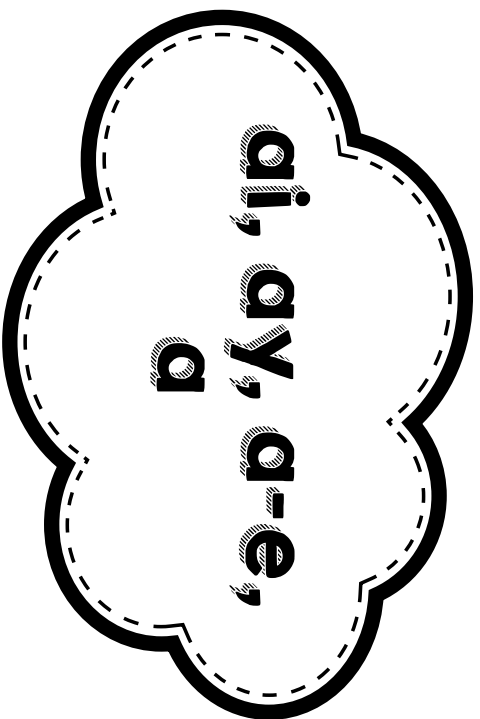

## Spelling Words

1. way
2. day
3. stay
4. rain
5. mail
6. paint
7. take
8. came
9. baby
10. lady

## Extension

1. holiday
2. place
3. awake
4. brain
5. afraid

Use pipe cleaners to write out your spelling words.	Draw one shape for each word. Write your spelling words inside each of the shapes.
Use magazines or newspapers to cut out the letters you need to spell your spelling words.	Type your spelling words on a computer.
Using grid paper, write out your spelling words. Put each sound in one box. Like this: Ch-ee-se	Group your spelling words according to the number of syllables.
Using your spelling words, write the vowels in blue and the consonants in red.	Draw a picture and hide your spelling words in the picture.
Put your spelling words in alphabetical order.	Use five of your spelling words in five sentences.

# Activity Grid

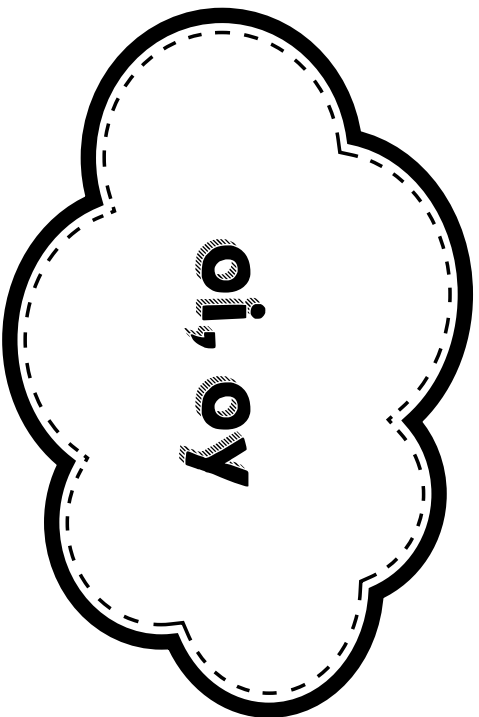

## Spelling Words

1. toy
2. coin
3. oil
4. joy
5. noise
6. boy
7. join
8. enjoy
9. voice
10. soil

## Extension

1. choice
2. spoil
3. enjoy
4. royal
5. annoy

Sort your spelling words into their phoneme groups (oi,oy).

Write out your spelling words in rainbow colours.

Using a container of water and a paintbrush, paint each of your spelling words on some concrete.

Write out your spelling words and draw matching pictures on flash cards. Play a game of memory or snap with a partner.

Write out each of your spelling words using dots.

Write out your spelling words. Circle the phoneme you are learning.

Build your spelling words using Lego or blocks.

Use chalk to write out your spelling words on concrete.

Use glue to write out each spelling word. Sprinkle glitter over the glue.

Write as many words as you can that rhyme with each of your spelling words.

# Activity Grid

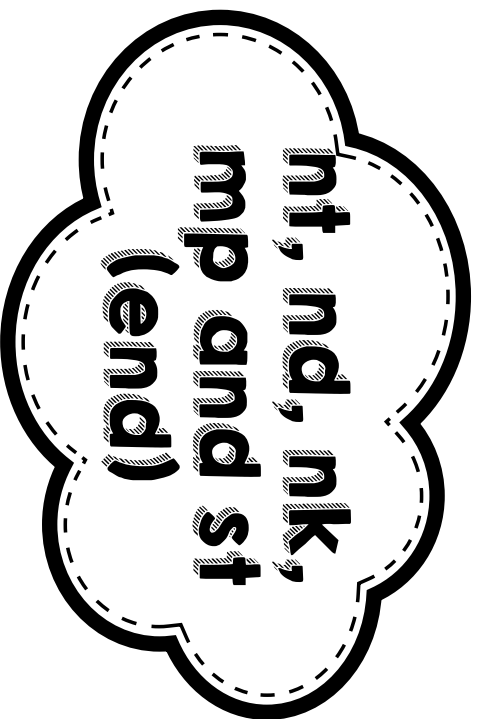

## Spelling Words

1. fast
2. plant
3. kind
4. stand
5. pink
6. sink
7. camp
8. jump
9. best
10. sent

## Extension

1. shrink
2. swamp
3. first
4. second
5. ancient

Sort your spelling words into their blend groups (nt,nd,nk,mp,st).	Write two more words for each blend.
Using your spelling words, write the vowels in blue and the consonants in red.	Group your spelling words according to the number of syllables.
Write a silly sentence for each spelling word.	Type your spelling words on a computer.
Put your spelling words in alphabetical order.	Use five of your spelling words in five sentences.
Draw one shape for each word. Write the spelling words inside each of the shapes.	Draw a picture and hide your spelling words in the picture.

# Activity Grid

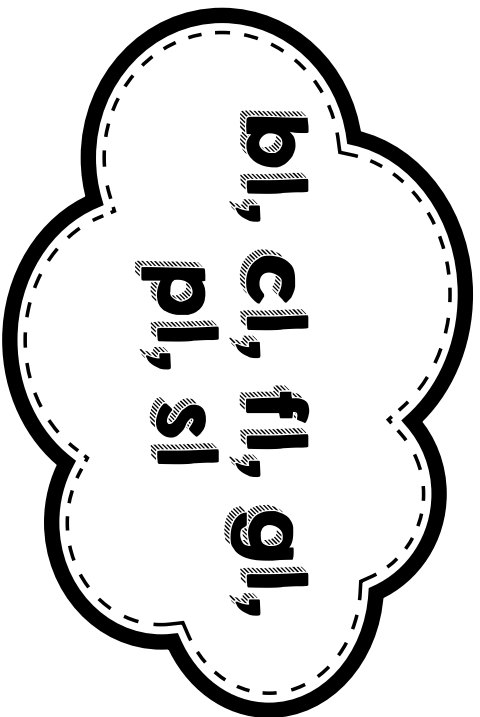

## Spelling Words

1. block
2. clock
3. flag
4. glass
5. plant
6. slide
7. plum
8. fly
9. glove
10. sleep

## Extension

1. clown
2. flower
3. please
4. blanket
5. planet

Sort your spelling words into their blend groups (bl,cl,fl,gl,pl,sl).	Write out each of your spelling words in rainbow colours.
Using a container of water and a paintbrush, paint each of your spelling words on some concrete.	Search through books to find your spelling words. Use tally marks to record how many times you find each word.
Jumble up the letters of your spelling words. Give them to a partner to unjumble.	Write as many words as you can that rhyme with each of your spelling words.
Use glue to write out each spelling word. Sprinkle glitter over the glue.	Write out your spelling words and draw matching pictures on flash cards. Play a game of memory or snap with a partner.
Write out each of your spelling words using dots.	Use chalk to write out your spelling words on concrete.

# Activity Grid

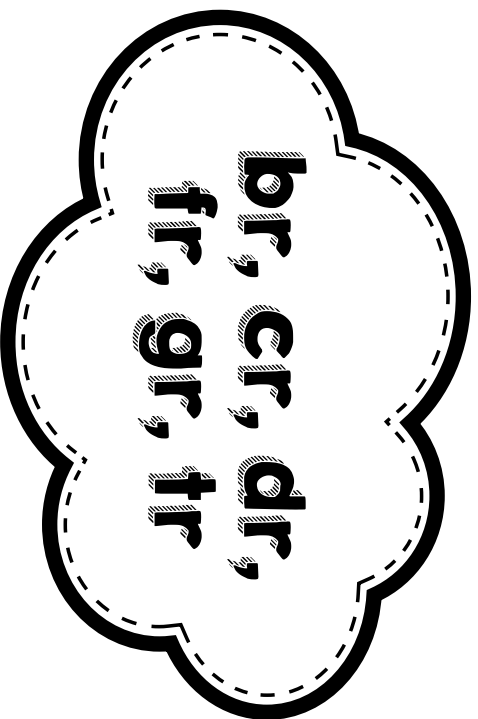

## Spelling Words

1. crab
2. frog
3. tree
4. dress
5. drip
6. truck
7. brush
8. drum
9. grin
10. train

## Extension

1. straw
2. string
3. frown
4. dream
5. drink

Sort your spelling words into their blend groups (br,cr,dr,fr,gf,tr).	Use five of your spelling words in five sentences.
Draw one shape for each word. Write your spelling words inside each of the shapes.	Group your spelling words according to the number of syllables.
Using grid paper, write out your spelling words. Put each sound (phoneme) in one box. Like this: Ch-ee-se	Type your spelling words on a computer.
Put your spelling words in alphabetical order.	Draw a picture and hide your spelling words in the picture.
Use magazines or newspapers to cut out the letters you need to spell your spelling words.	Using your spelling words, write the vowels in blue and the consonants in red.



## Word Work Grid

Complete each of the activities in this grid. Write the date you completed each activity on the line provided.

<p><b>Syllable Sort</b> Write your spelling words in order from the least amount of syllables to the most. Words with the same number of syllables should be in alphabetical order.</p> <p>Date: _____</p>	<p><b>Odd One Out</b> For each of your spelling words, write four words. One is your spelling word, two relate to your spelling word and one is the odd word out that doesn't fit with the other two.</p> <p>Date: _____</p>	<p><b>Wacky Words</b> On a sheet of paper, write your spelling words in different directions, filling up the whole sheet. Use different colours and types of writing for each word.</p> <p>Date: _____</p>	<p><b>Word Detective</b> Write three clues about each of your spelling words. Ask someone to try to guess your spelling words using your clues.</p> <p>Date: _____</p>	<p><b>Digging in the Dictionary</b> Use a dictionary to find the definition and write a sentence for each of your spelling words.</p> <p>Date: _____</p>
<p><b>Rhyming Wheels</b> Think of as many words as you can that rhyme with your spelling words.</p> <p>Date: _____</p>	<p><b>Alliteration</b> Write a sentence for each of your spelling words using as much alliteration as possible.</p> <p>Date: _____</p>	<p><b>Sentence Smart</b> Write a sentence for each of your spelling words.</p> <p>Date: _____</p>	<p><b>Story Time</b> Write a story using as many of your spelling words as you can. Underline each of your spelling words.</p> <p>Date: _____</p>	<p><b>Sort Them Out</b> Sort the words on your spelling list into three different categories of your choice.</p> <p>Date: _____</p>
<p><b>Word Search</b> Create your own word search using all the words on your spelling list.</p> <p>Date: _____</p>	<p><b>Handwriting Hero</b> Write out your spelling words in your very best cursive hand writing.</p> <p>Date: _____</p>	<p><b>Letter Lingo</b> Write a letter to a friend. Use as many spelling words in your letter as you can.</p> <p>Date: _____</p>	<p><b>Words Within Words</b> Make a list of as many smaller words as you can find from your spelling list.</p> <p>Date: _____</p>	<p><b>Code Breaker</b> Use the code guide to make a code for each of your spelling words.</p> <p>Date: _____</p>



## Rhyming Wheels

Write as many words as you can that rhyme with the sound in the rhyming wheel. Use the alphabet at the bottom to help you think of more words.

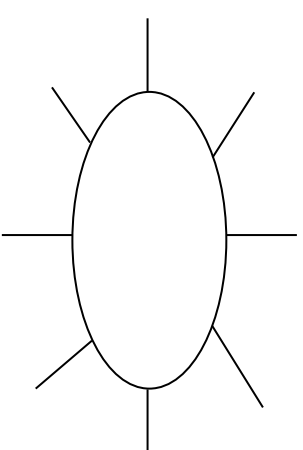
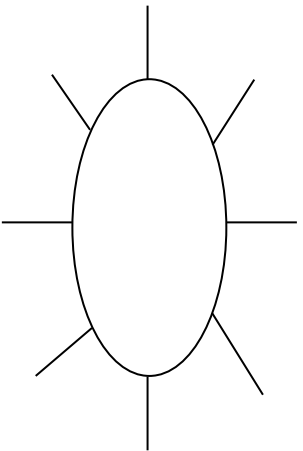
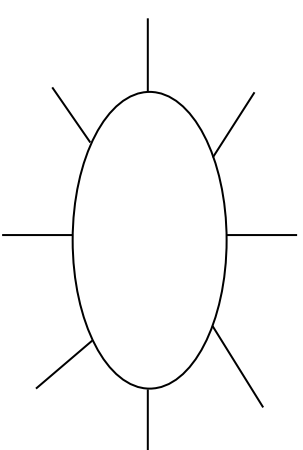
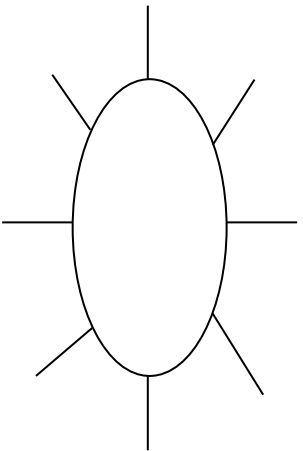

A B C D E F G H I J K L M N O P Q R S T U V W X Y Z

---

---

---

---

---

---

---

---

---

---

---

---

---

---

---

---

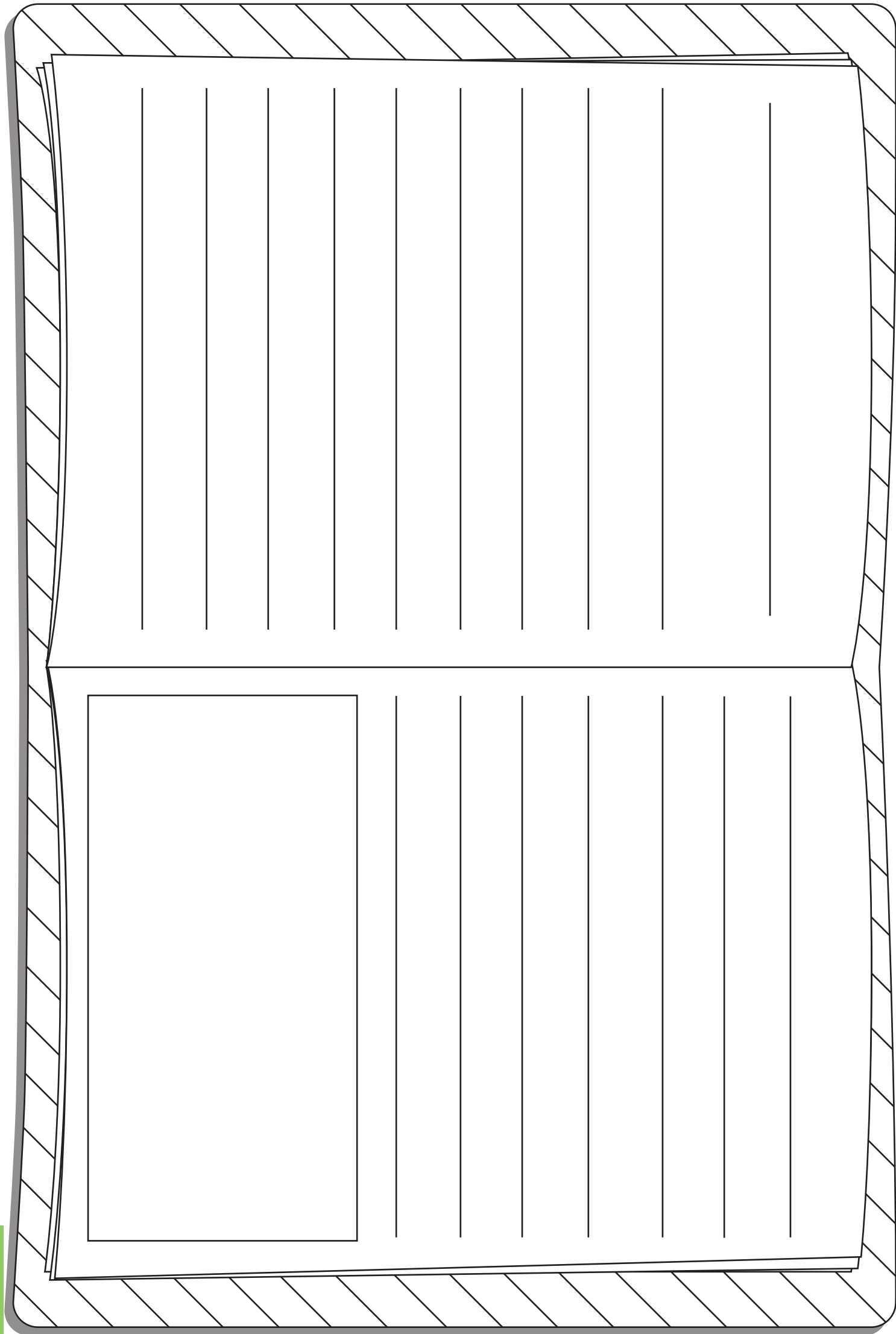



## Digging in the Dictionary

Write your spelling word in the first column, the definition from the dictionary in the second column and the word in a sentence in the third column.

<b>Spelling Word</b>	<b>Definition</b>	<b>Sentence</b>





## Odd One Out

Write four words for each of your spelling words. One is your spelling word, two relate to your spelling word and one is the odd word out that doesn't fit with the other three.

e.g. happy, joyful, angry, cheerful

a) \_\_\_\_\_

b) \_\_\_\_\_

c) \_\_\_\_\_

d) \_\_\_\_\_

e) \_\_\_\_\_

f) \_\_\_\_\_

g) \_\_\_\_\_

h) \_\_\_\_\_

i) \_\_\_\_\_

j) \_\_\_\_\_

k) \_\_\_\_\_

l) \_\_\_\_\_

m) \_\_\_\_\_

n) \_\_\_\_\_

o) \_\_\_\_\_



## Sort Them Out

Choose three different categories to sort your spelling words. A spelling word may go in more than one category.

<b>Category 1:</b>	<b>Category 2:</b>	<b>Category 3:</b>

## Word Detective

Write three clues about each of your spelling words. Ask someone to try to guess your spelling words using your clues.

a) \_\_\_\_\_

b) \_\_\_\_\_

c) \_\_\_\_\_

a) \_\_\_\_\_

b) \_\_\_\_\_

c) \_\_\_\_\_

a) \_\_\_\_\_

b) \_\_\_\_\_

c) \_\_\_\_\_

a) \_\_\_\_\_

b) \_\_\_\_\_

c) \_\_\_\_\_



# SUPERFOODS

## What's for Lunch?



BELL  
RINGS  
FOR  
RECESS

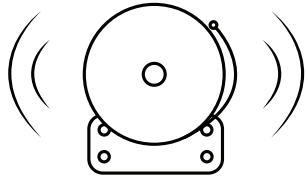

Why did you  
throw away  
your lunch?

I don't like  
sandwiches.

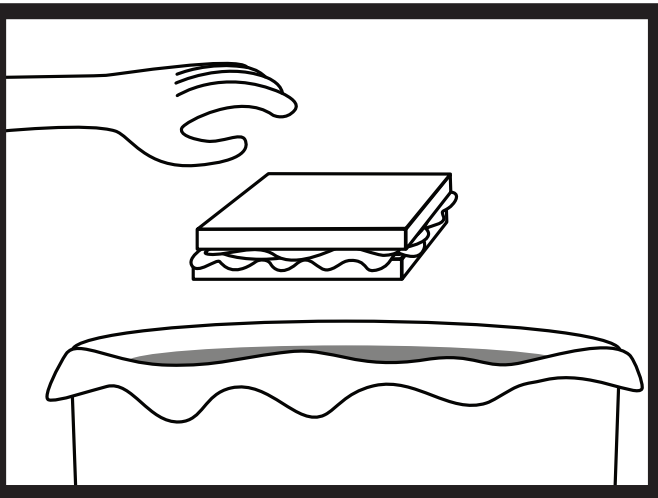

You don't like  
sandwiches?

No way!

Have you told  
your dad you  
do not like them?

No.

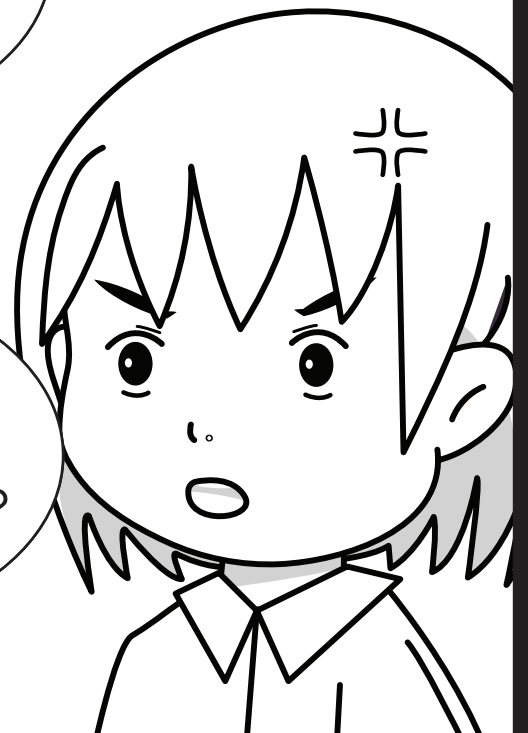

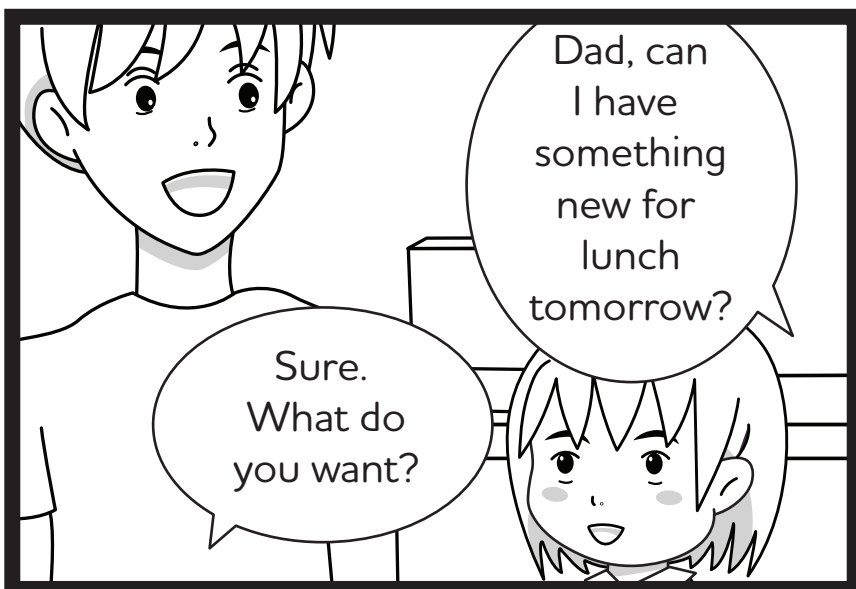
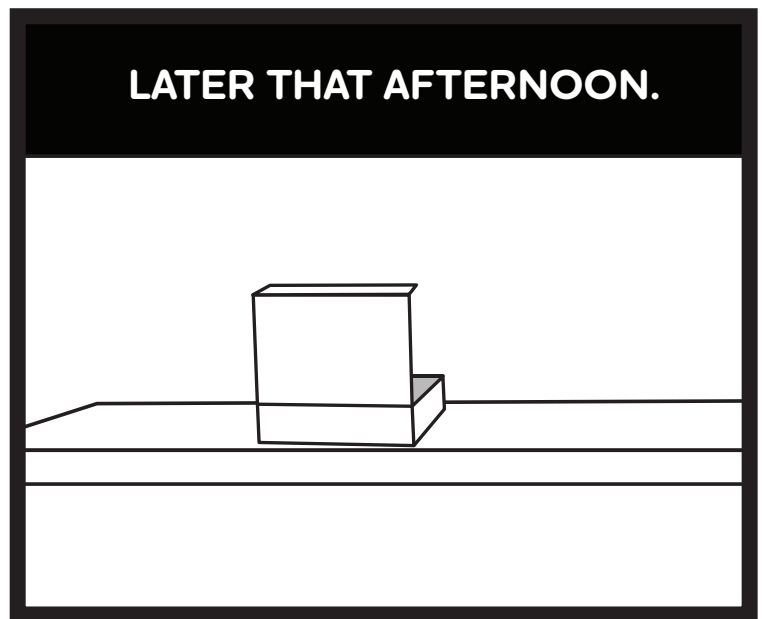

Name: \_\_\_\_\_

Date: \_\_\_\_\_

# Superfoods: What's for Lunch?

## Questions



1. Why do you think the girl in the comic is not happy?

---

---

2. What does the boy tell her to do?

---

---

3. Has there been a time you were given a lunch you did not like?  
When was that?

---

---

4. List some foods you know that are healthy.

---

---

5. Suggest a lunch for the girl that is both delicious and healthy.  
Draw it below.



Name: \_\_\_\_\_

Date: \_\_\_\_\_

# Search-a-Rooney #2

## Questions

1. Name five animals you can see on this page. Can you name more?

---

---

---

---

---

2. Look at the picture and describe an animal that you have never seen before.

---

---

---

3. What animal did you describe?

---

4. Which of the drawn characters would be a leader? Why?

---

---

---

5. Choose a drawn character to write about. Write about who you think they are.

---

---



# My Book Report for

---

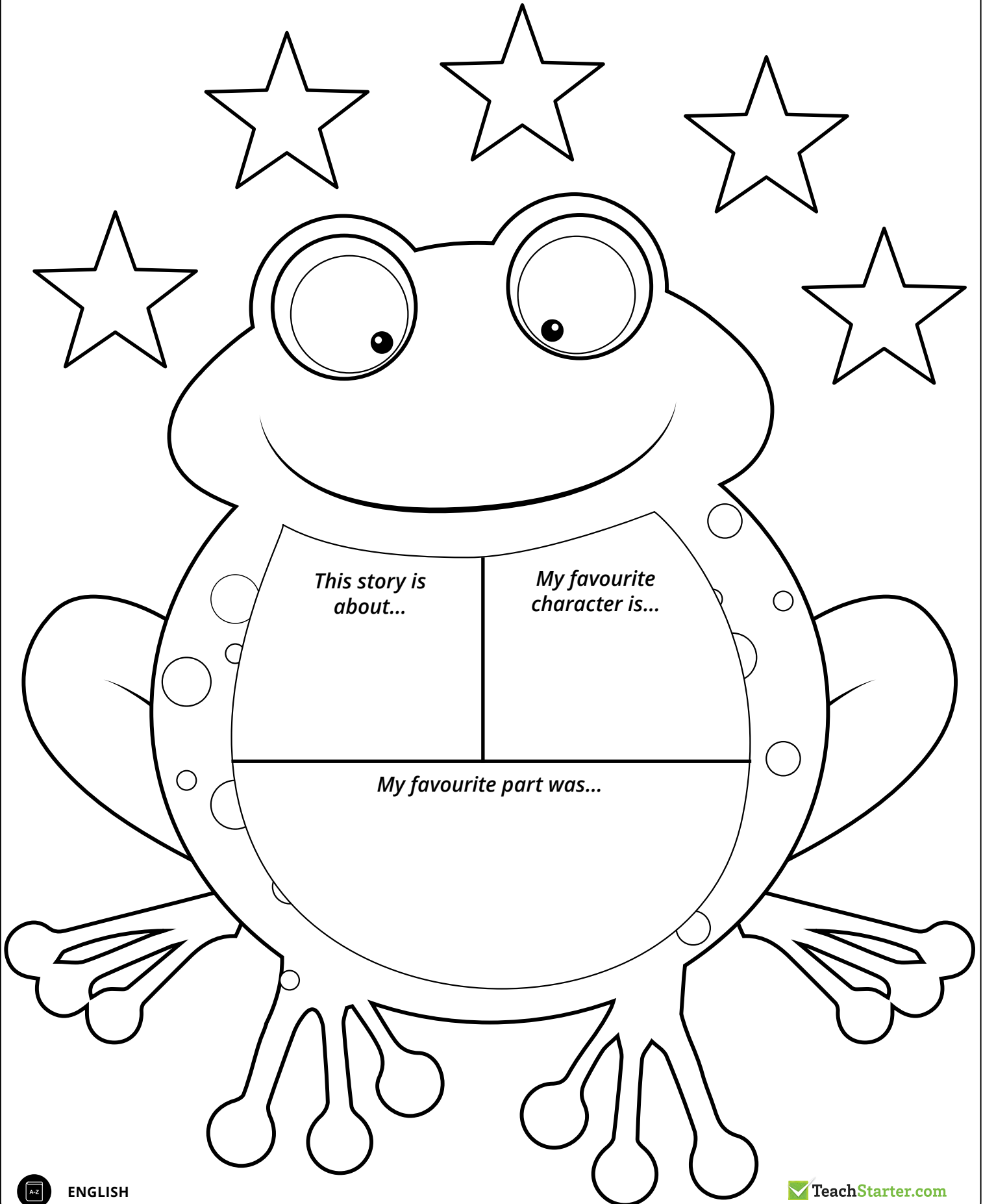

# My Book Report

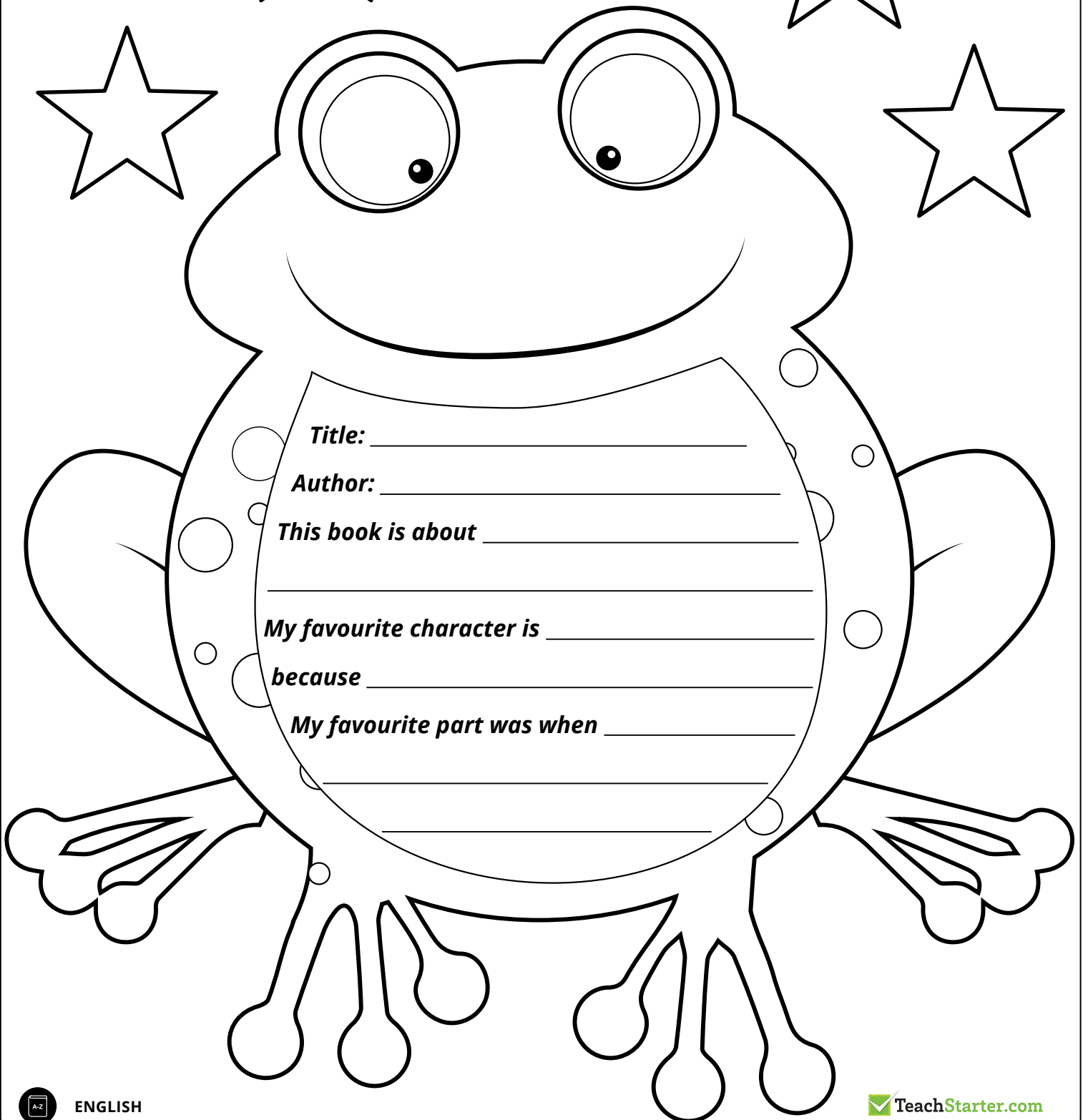
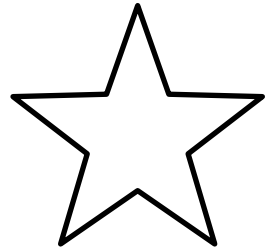
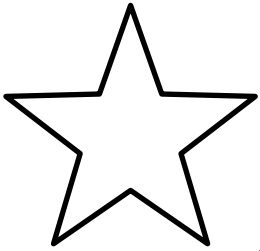
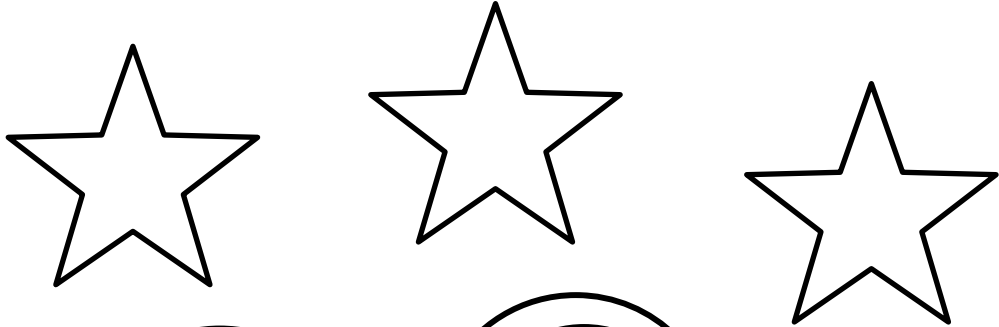

**Title:** \_\_\_\_\_

**Author:** \_\_\_\_\_

**This book is about** \_\_\_\_\_  
\_\_\_\_\_

**My favourite character is** \_\_\_\_\_

**because** \_\_\_\_\_

**My favourite part was when** \_\_\_\_\_  
\_\_\_\_\_

# My Book Report for

\_\_\_\_\_

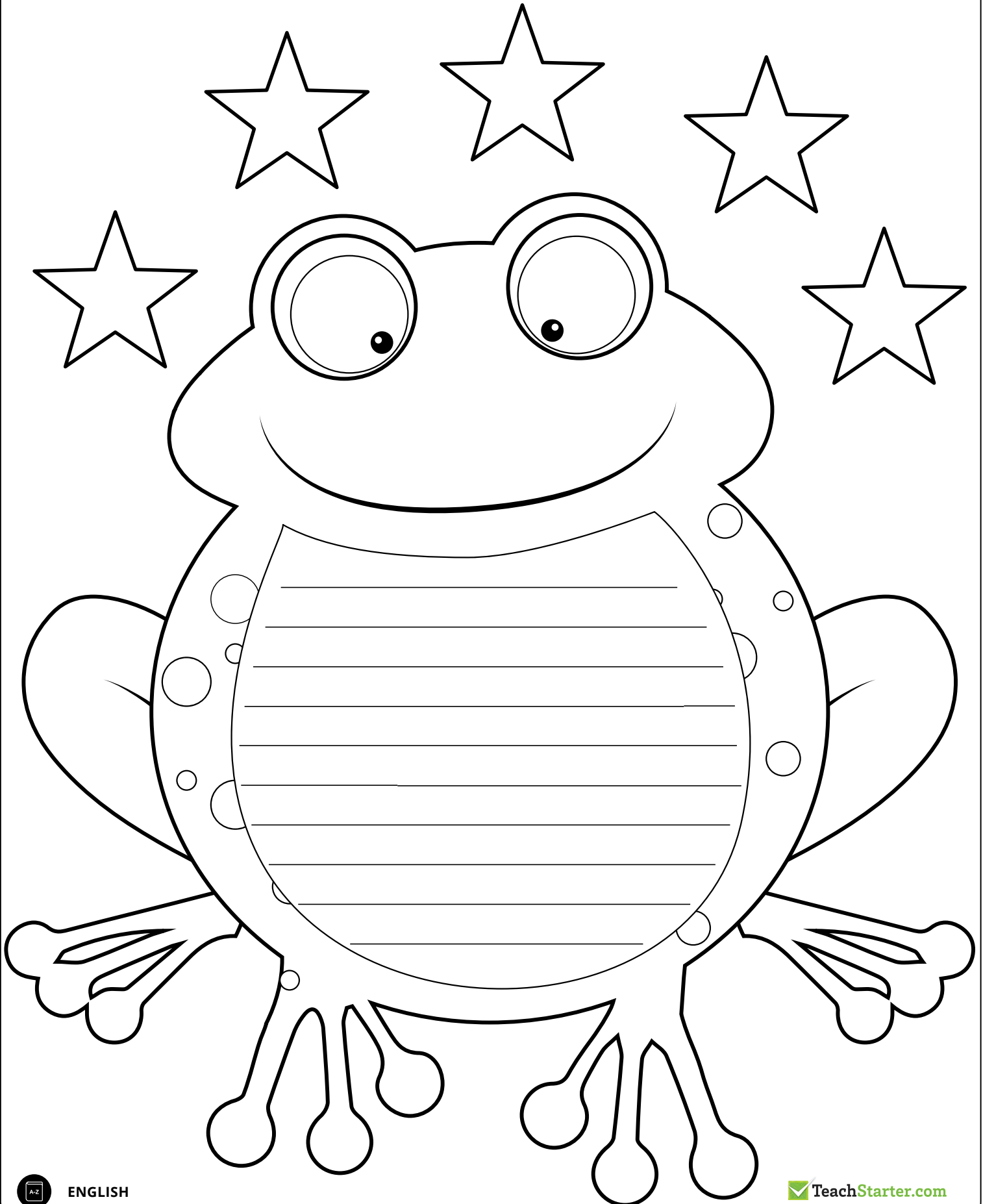

# Jack and the Beanstalk

Once upon a time there was a boy called Jack. He lived with his mother. They were very poor. The only thing that they owned was a cow.

One morning, Jack's mother told Jack to take their cow to market and sell her for money. On the way to the market, Jack met a man. The man asked Jack if he would sell the cow for some magic beans. Jack took the beans for the cow and went back home. When Jack's mother saw the beans, she was very angry. She was so cross that she threw the beans out of the window.

The next morning, Jack looked out of the window. He saw a giant beanstalk. He went outside and started to climb the tall beanstalk. He climbed up and up to the sky and through the clouds. Above the clouds, Jack saw a beautiful castle. He went into the castle. Then, Jack heard a loud voice. It was the voice of an enormous giant. Jack felt scared.

"Fee, Fi, Fo, Fum!" said the giant.

Jack ran into a cupboard to hide. The big giant came into the room and sat down. On the table there was a hen and a golden harp.

"Lay!" said the giant. The hen laid an egg. It was made of gold.

"Sing!" said the giant. The harp began to sing.

After a little while, the giant fell asleep. Jack jumped out of the cupboard. He thought that his mother would like the magic hen and the magic harp. So, he took the hen and the harp.

Suddenly, the harp sang, "Help, master!" The giant woke up and shouted, "Fee, Fi, Fo, Fum!"

Jack ran and started climbing down the beanstalk. The giant came down after him.

"Mother, help!" Jack shouted.

Jack's mother took an axe and chopped down the beanstalk. The giant fell and crashed to the ground. With the golden eggs and the magic harp, Jack and his mother lived happily ever after.

# Jack and the Beanstalk

Once upon a time there was a boy called Jack. He lived with his mother. They were very poor. The only thing that they owned was a cow.

One morning, Jack's mother told Jack to take their cow to market and sell her for money. On the way to the market, Jack met a man. The man asked Jack if he would sell the cow for some magic beans. Jack took the beans for the cow and went back home. When Jack's mother saw the beans, she was very angry. She was so cross that she threw the beans out of the window.

The next morning, Jack looked out of the window. He saw a giant beanstalk. He went outside and started to climb the tall beanstalk. He climbed up and up to the sky and through the clouds. Above the clouds, Jack saw a beautiful castle. He went into the castle. Then, Jack heard a loud voice. It was the voice of an enormous giant. Jack felt scared.

"Fee, Fi, Fo, Fum!" said the giant.

Jack ran into a cupboard to hide. The big giant came into the room and sat down. On the table there was a hen and a golden harp.

"Lay!" said the giant. The hen laid an egg. It was made of gold.

"Sing!" said the giant. The harp began to sing.

After a little while, the giant fell asleep. Jack jumped out of the cupboard. He thought that his mother would like the magic hen and the magic harp. So, he took the hen and the harp.

Suddenly, the harp sang, "Help, master!" The giant woke up and shouted, "Fee, Fi, Fo, Fum!"

Jack ran and started climbing down the beanstalk. The giant came down after him.

"Mother, help!" Jack shouted.

Jack's mother took an axe and chopped down the beanstalk. The giant fell and crashed to the ground. With the golden eggs and the magic harp, Jack and his mother lived happily ever after.

Name \_\_\_\_\_

Date \_\_\_\_\_

## Capital Letter and Full Stop Scavenger Hunt

As a class, read the following passage from the fairy tale, *Jack and the Beanstalk*.

**Once upon a time there was a boy called Jack. He lived with his mother. They were very poor. The only thing that they owned was a cow.**

**Jack's mother told Jack to take their cow to market and sell her for money. On the way to the market, Jack met a man. The man asked Jack if he would sell the cow for some magic beans. Jack took the beans for the cow and went back home. When Jack's mother saw the beans, she was very angry. She was so cross that she threw the beans out of the window.**

When you have read the passage:

- hunt for capital letters and full stops
- underline the capital letters and put a circle around the full stops (the capital letters and full stops in the first sentence have been found for you)
- create a tally to show the number of capital letters and full stops that you have found.

Capital Letters and Full Stops - Tally Marks		Total
full stops		
capital letters		

Name \_\_\_\_\_

Date \_\_\_\_\_

## Hunt It and Fix It!

Capital letters are used at the start of a sentence and for proper nouns.

Full stops are used at the end of a sentence.

The following sentences **do not** have capital letters and full stops.

Rewrite each sentence by adding capital letters and full stops in the correct places.

1. once upon a time there was a boy called jack

---

---

---

2. the big giant came into the room and sat down

---

---

---

3. the giant fell and crashed to the ground

---

---

---

4. the man asked jack if he would sell the cow for some magic beans

---

---

---

5. jack and his mother were very poor

---

---

---

Name: \_\_\_\_\_

Date: \_\_\_\_\_

# Nouns, Verbs and Adjectives Sort

Cut out the words and paste them into the table under their correct heading.

apple	read	large	ball
skateboard	kitten	cook	fastest
lonely	whisper	school	old
teacher	red	yell	run
cold	lazy	purple	fish
dinosaur	crazy	hop	hat



Name: \_\_\_\_\_

Date: \_\_\_\_\_

## Nouns, Verbs and Adjectives Sort

<b>Nouns</b>	<b>Verbs</b>	<b>Adjectives</b>

Name \_\_\_\_\_

Date \_\_\_\_\_

## Listening to Audio Books is Better Than Reading Books

Cut out the for and against statements below arguing why listening to audio books is or is not better than reading books. Paste each statement under the correct heading on the next page.

Audio books develop good listening skills.

Audio books are more expensive to buy than books.

Listening to an audio book is more interesting than reading.

Real books help to develop important reading skills.

Audio books require batteries.

Audio books can be listened to whilst doing other activities.

Real books can be taken anywhere.

Audio books uses a persons imagination to picture a story.



WRITING

Name \_\_\_\_\_

Date \_\_\_\_\_

## Listening to Audio Books is Better Than Reading Books

FOR

AGAINST

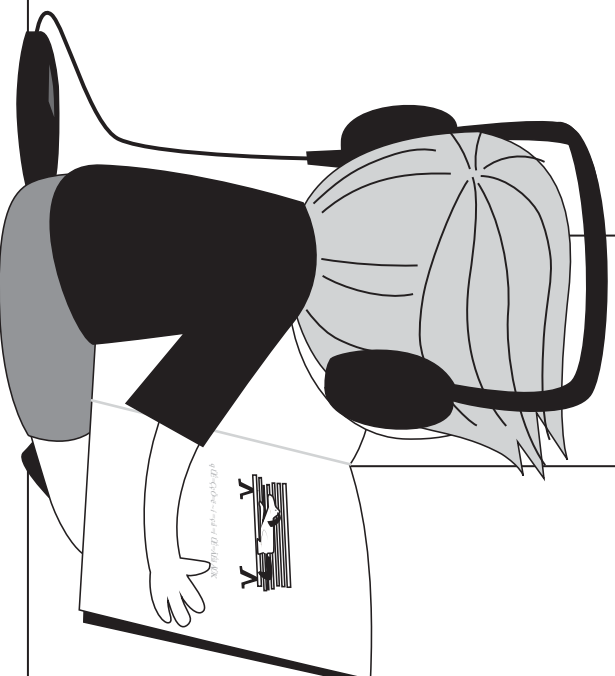

WRITING

# Story Map

Title \_\_\_\_\_

**Characters**

**Setting**

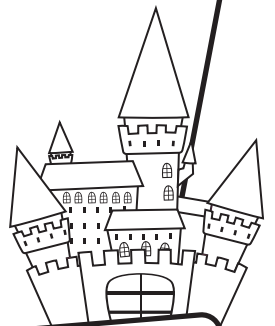

**What else happened?**

**Problem**



**Solution**



Name: \_\_\_\_\_

Date: \_\_\_\_\_

3.

4.

5.

6.

2.

1.

2. Until one day...

3. Because of that...

4. That caused...

5. Which led to...

6. Until finally...

7. Ever since...

8. The moral is...

1. Every day...

My Story Title

7.

8.



Conclusion

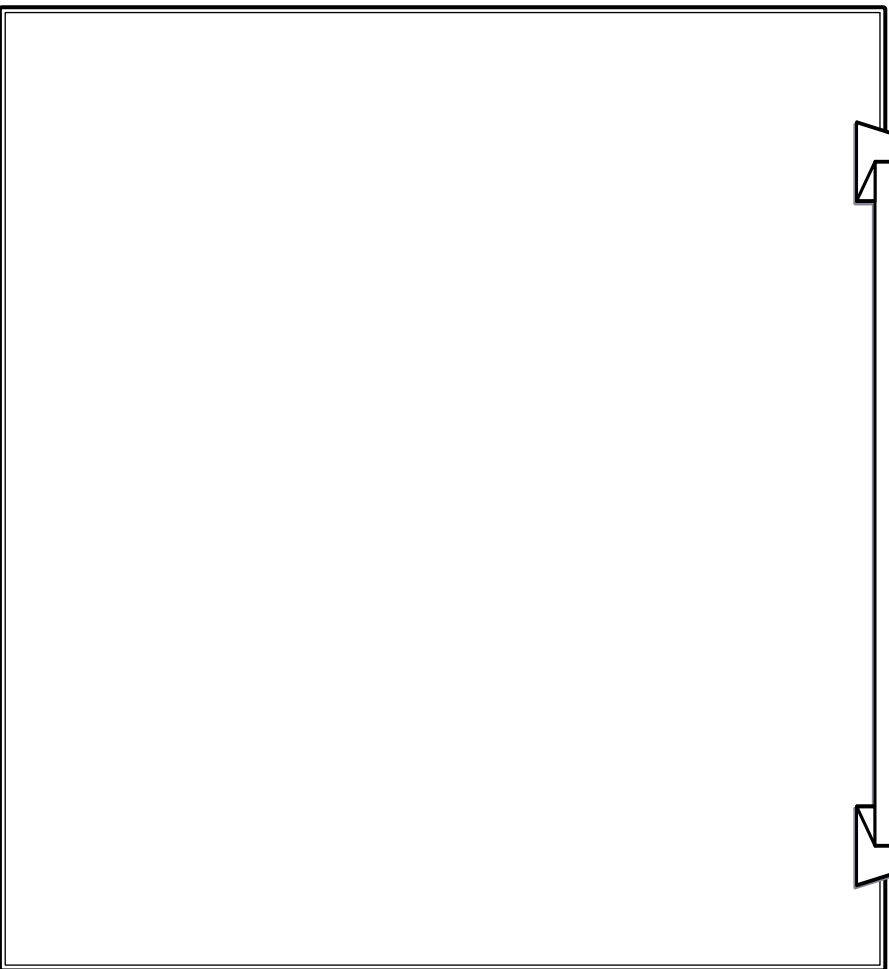

---

---

---

---

---

---

---

---

INFORMATIVE WRITING

# ANIMAL RESEARCH TASK

Facts About

-----

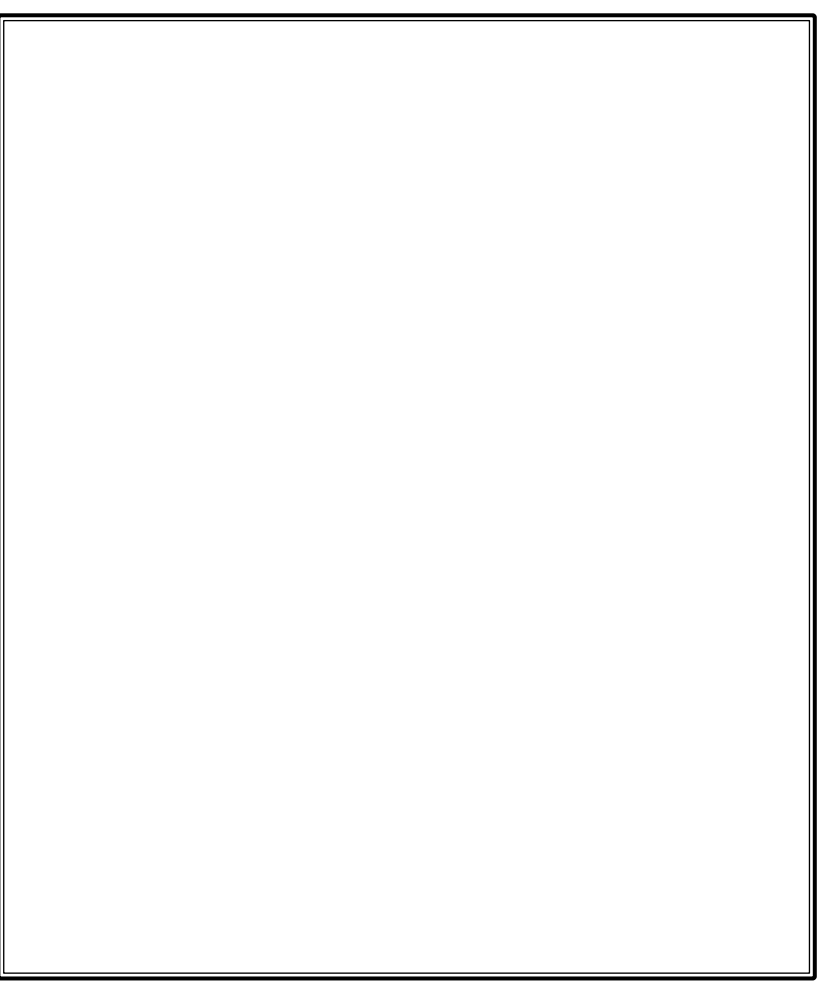

By

-----

Date

-----

## General Classification

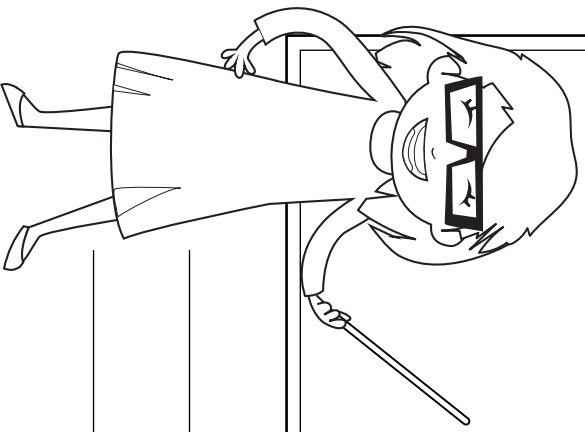

---

---

---

---

---

---

---

---

## Interesting Facts

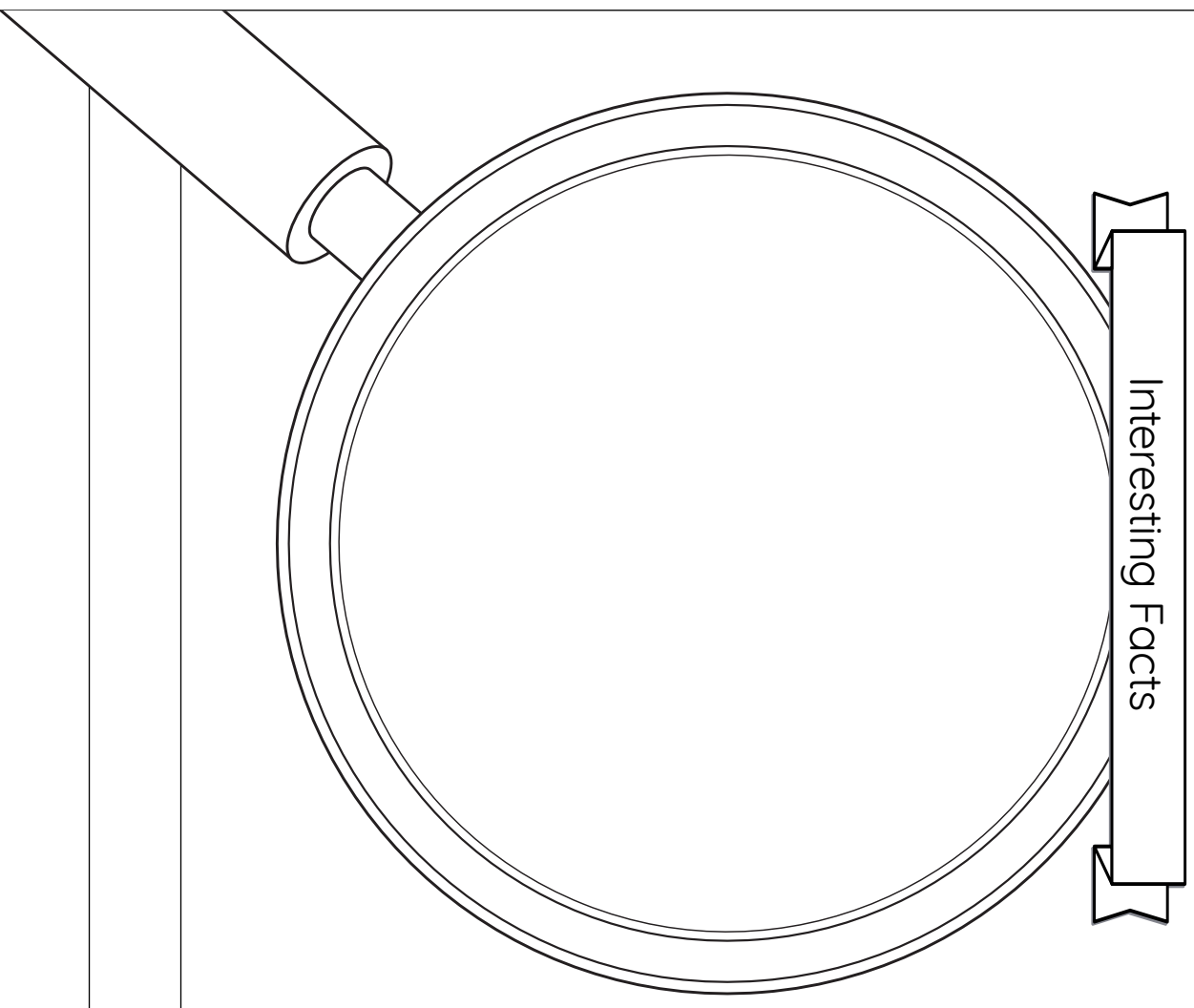

---

---

---

---

---

---

---

---

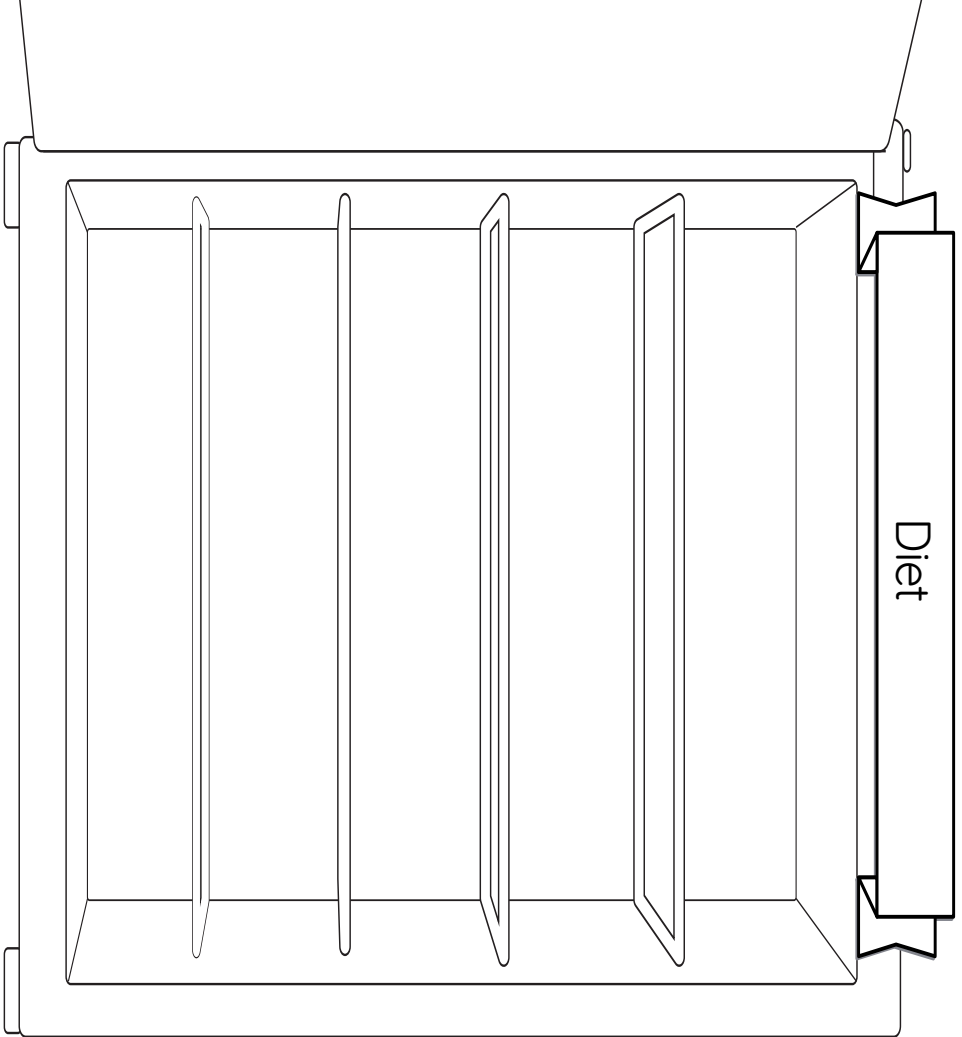

---

---

---

---

---

3

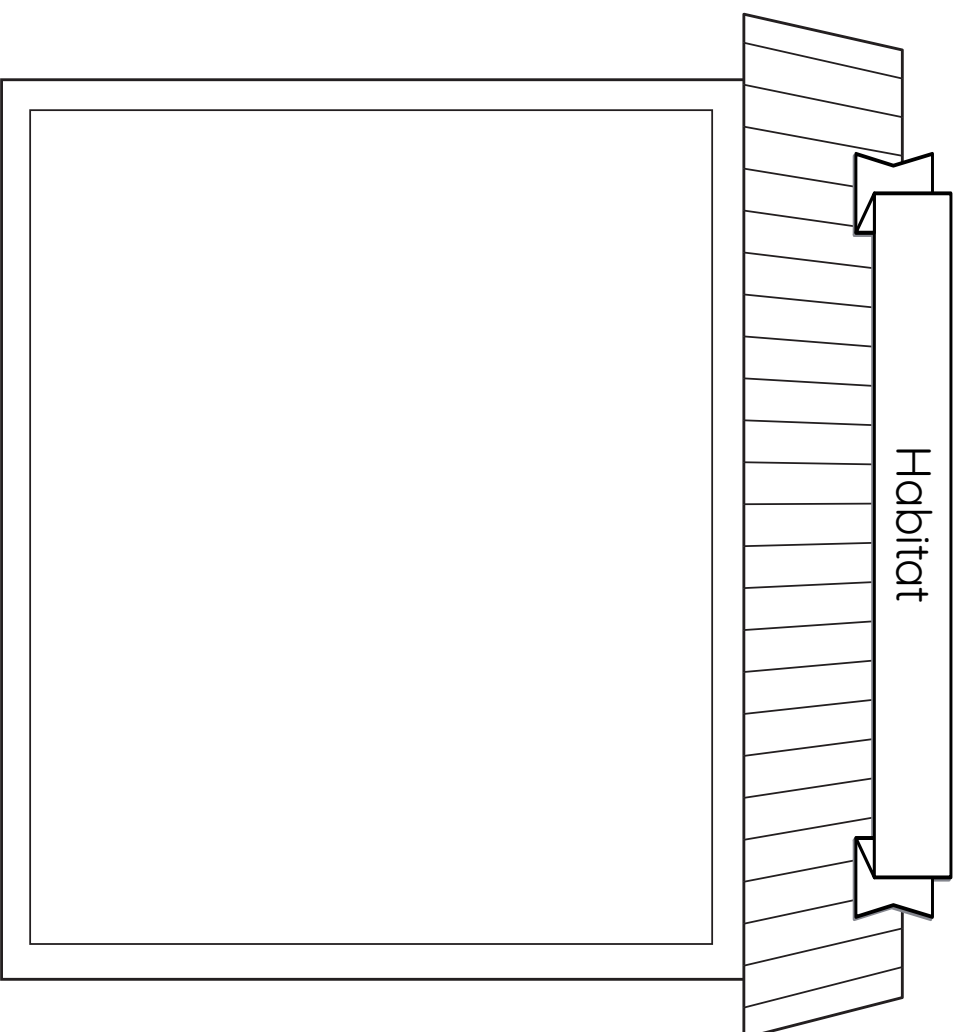

---

---

---

---

---

4



Is like ...

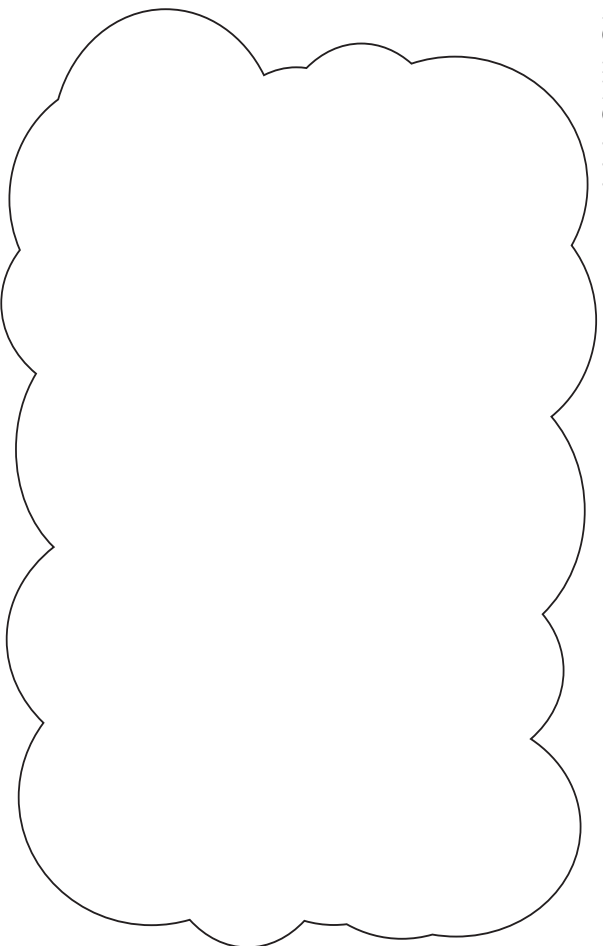

Is different to ...

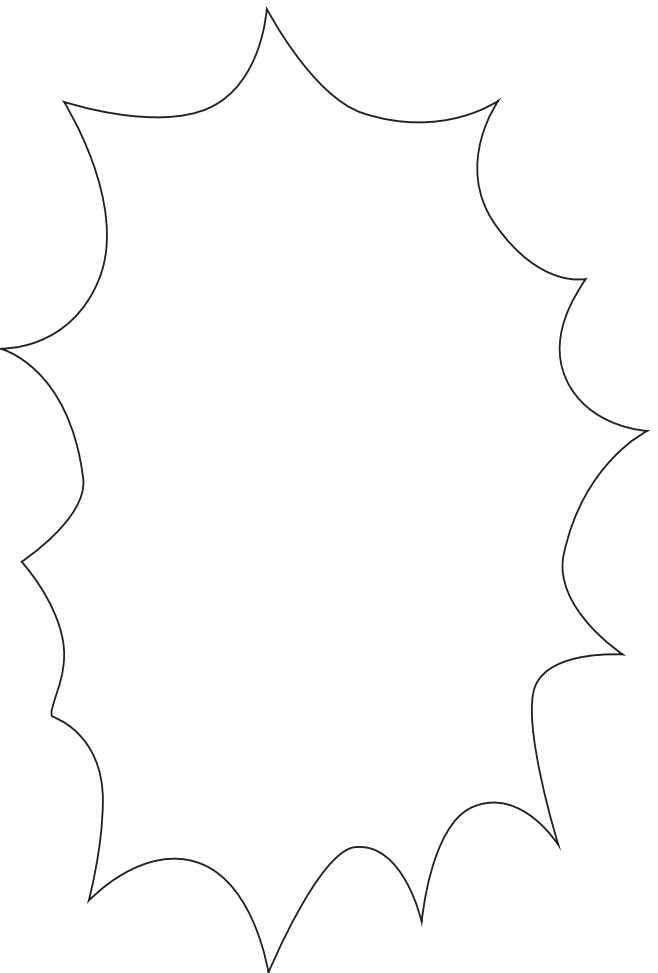

# Characteristics

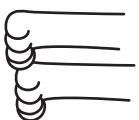

Handwriting practice lines consisting of ten horizontal lines for writing.

# Hundreds Board

Mystery Picture No. \_\_\_\_\_

1	2	3	4	5	6	7	8	9	10
11	12	13	14	15	16	17	18	19	20
21	22	23	24	25	26	27	28	29	30
31	32	33	34	35	36	37	38	39	40
41	42	43	44	45	46	47	48	49	50
51	52	53	54	55	56	57	58	59	60
61	62	63	64	65	66	67	68	69	70
71	72	73	74	75	76	77	78	79	80
81	82	83	84	85	86	87	88	89	90
91	92	93	94	95	96	97	98	99	100

# Hundreds Board

Mystery Picture No. \_\_\_\_\_

### Mystery Picture 1

**Green:** 65, 66, 73, 74, 75, 76, 77, 78, 84, 85, 86, 87, 95, 96

**Yellow:** 25, 26, 35, 36

**Pink:** 4, 5, 6, 7, 13, 14, 15, 16, 17, 18, 22, 23, 24, 27, 28, 29, 32, 33, 34, 37, 38, 39, 43, 44, 45, 46, 47, 48, 54, 55, 56, 57



### Mystery Picture 2

**Purple:** 65, 66, 75, 76

**Orange:** 33, 34, 35, 36, 37, 38, 42, 43, 48, 49, 52, 59, 62, 69, 72, 79, 82, 89

**Blue:** 1, 2, 3, 4, 5, 6, 7, 8, 9, 10, 11, 12, 19, 20, 21, 30, 85, 86, 91, 92, 93, 94, 95, 96, 97, 98, 99, 100

**Green:** 55, 56, 64, 67, 74, 77, 84, 87

**Red:** 13, 14, 15, 16, 17, 18, 22, 23, 24, 25, 26, 27, 28, 29, 31, 32, 39, 40, 41, 50, 51, 60, 61, 70, 71, 80, 81, 90

**Yellow:** 44, 45, 46, 47, 53, 54, 57, 58, 63, 68, 73, 78, 83, 88



### Mystery Picture 3

**Black:** 26, 27, 36, 37, 54, 55, 58, 59, 64, 65, 68, 69, 83, 89

**Green:** 81, 82, 84, 85, 86, 87, 88, 90, 91, 92, 93, 94, 95, 96, 97, 98, 99, 100

**Blue:** 1, 2, 3, 4, 5, 6, 7, 8, 9, 10, 11, 12, 13, 14, 19, 20, 21, 22, 23, 30, 31, 32, 71

**Red:** 15, 16, 17, 18, 24, 25, 28, 29, 33, 34, 35, 38, 39, 40, 44, 45, 46, 47, 48, 49, 50, 56, 57, 60, 66, 67, 70, 72, 73, 74, 75, 76, 77, 78, 79, 80

Add eyes, antennae and a smile to the picture.



### Mystery Picture 4

**Red:** 2, 9, 12, 14, 17, 19, 21, 22, 23, 28, 29, 30, 31, 40, 41, 50, 51, 52, 53, 54, 55, 56, 57, 58, 59, 60, 63, 64, 65, 66, 67, 68, 73, 74, 75, 76, 77, 78, 83, 84, 85, 86, 87, 88, 92, 94, 97, 99

**Black:** 44, 48

**Blue:** 1, 3, 4, 5, 6, 7, 8, 10, 11, 13, 15, 16, 18, 20, 24, 25, 26, 27, 32, 35, 36, 39, 42, 45, 46, 49, 61, 62, 69, 70, 71, 72, 79, 80, 81, 82, 89, 90, 91, 93, 95, 96, 98, 100

Add a smile to the picture.



### Mystery Picture 5

**Black:** 24, 27

**Blue:** 1, 2, 3, 4, 5, 6, 7, 8, 9, 10, 11, 12, 15, 16, 19, 20, 21, 22, 25, 26, 29, 30, 31, 32, 39, 40, 41, 50, 51, 52, 59, 60, 81, 90, 91, 92, 95, 96, 99, 100

**Green:** 33, 34, 35, 36, 37, 38, 42, 43, 44, 45, 46, 47, 48, 49, 53, 54, 55, 56, 57, 58, 61, 62, 63, 64, 65, 66, 67, 68, 69, 70, 71, 72, 73, 74, 75, 76, 77, 78, 79, 80, 82, 83, 84, 85, 86, 87, 88, 89, 93, 94, 97, 98

Add a smile to the picture.



### Mystery Picture 6

**Black:** 34, 37, 63, 68, 74, 75, 76, 77

**Yellow:** 4, 5, 6, 7, 13, 14, 15, 16, 17, 18, 22, 23, 24, 25, 26, 27, 28, 29, 31, 32, 33, 35, 36, 38, 39, 40, 41, 42, 43, 44, 45, 46, 47, 48, 49, 50, 51, 52, 53, 54, 55, 56, 57, 58, 59, 60, 61, 62, 64, 65, 66, 67, 69, 70, 72, 73, 78, 79, 83, 84, 85, 86, 87, 88, 94, 95, 96, 97



### Mystery Picture 7

**Brown:** 75, 76, 85, 86, 95, 96

**Red:** 14, 18, 33, 37, 56

**Green:** 3, 4, 5, 6, 7, 8, 12, 13, 15, 16, 17, 19, 21, 22, 23, 24, 25, 26, 27, 28, 29, 30, 31, 32, 34, 35, 36, 38, 39, 40, 41, 42, 43, 44, 45, 46, 47, 48, 49, 50, 52, 53, 54, 55, 57, 58, 59, 63, 64, 65, 66, 67, 68



### Mystery Picture 8

**Yellow:** 55, 56

**Blue:** 1, 2, 3, 8, 9, 10, 11, 12, 19, 20, 21, 30, 31, 34, 37, 40, 41, 50, 51, 60, 61, 62, 69, 70, 71, 80

**Black:** 4, 5, 6, 7, 13, 14, 15, 16, 17, 18, 22, 25, 26, 29, 32, 35, 36, 39, 42, 43, 44, 45, 46, 47, 48, 49, 52, 53, 54, 57, 58, 59, 63, 64, 65, 66, 67, 68, 72, 73, 78, 79, 81, 82, 89, 90, 91, 100



### Mystery Picture 9

**Orange:** 53, 54, 55, 56, 57, 58, 64, 65, 66, 67, 75, 76

**Green:** 1, 2, 3, 8, 9, 10, 11, 12, 19, 20, 21, 30, 62, 63, 68, 69, 71, 72, 73, 78, 79, 80, 81, 82, 89, 90, 91, 100

**Blue:** 74, 77, 83, 88, 92, 93, 98, 99

**Yellow:** 4, 5, 6, 7, 13, 14, 15, 16, 17, 18, 22, 29, 31, 32, 39, 40, 41, 42, 49, 50, 51, 52, 59, 60, 61, 70

**Red:** 84, 85, 86, 87, 94, 95, 96, 97

**Black:** 23, 24, 25, 26, 27, 28, 33, 35, 36, 38, 43, 44, 45, 46, 47, 48

**Black circle:** 34, 37

Add a smile to the picture.



### Mystery Picture 10

**Black:** 25, 26, 32, 35, 36, 39, 42, 45, 46, 49, 55, 56, 65, 66, 73, 75, 76, 78, 83, 85, 86, 88, 95, 96

**Yellow:** 33, 38, 43, 48, 72, 79, 82, 89

**Light blue:** 61, 62, 63, 64, 67, 68, 69, 70, 71, 74, 77, 80, 81, 84, 87, 90, 92, 93, 98, 99

**Dark blue:** 22, 23, 28, 29, 31, 34, 37, 40, 41, 44, 47, 50, 52, 53, 54, 57, 58, 59

Add black antennae to the picture.



### Mystery Picture 11

**Black:** 33, 38

**Pink:** 54, 55, 56, 57, 65, 66, 93, 94, 97, 98

**Purple:** 2, 9, 12, 13, 14, 17, 18, 19, 21, 25, 26, 30, 31, 35, 36, 40, 41, 45, 46, 50, 51, 52, 53, 58, 59, 60, 62, 63, 64, 67, 68, 69, 73, 74, 75, 76, 77, 78, 84, 85, 86, 87



### Mystery Picture 12

**Red:** 11, 12, 21, 22, 23, 33, 34, 44

**Blue:** 41, 42, 51, 52, 61, 62, 71, 72

**Yellow:** 73

**Green:** 1, 2, 3, 4, 5, 6, 7, 8, 9, 10, 13, 14, 15, 16, 17, 18, 19, 20, 24, 27, 28, 31, 32, 35, 40, 45, 50, 60, 70, 76, 77, 78, 79, 80, 82, 83, 84, 85, 87, 88, 89, 90, 91, 92, 93, 94, 95, 96, 97, 98, 99, 100

**Pink:** 25, 26, 29, 30, 36, 37, 38, 39, 46, 49, 54, 55, 56, 57, 58, 59, 64, 65, 66, 67, 68, 69, 74, 75, 81, 86

**Black:** 43, 53, 63

**Black circle:** 47, 48



### Mystery Picture 13

**Orange:** 1, 4, 7, 10, 12, 19, 31, 40, 61, 70, 82, 89, 91, 94, 97, 100

**Black:** 33, 34, 37, 38, 42, 43, 44, 45, 46, 47, 48, 49, 53, 54, 57, 58

**Yellow:** 14, 15, 16, 17, 23, 24, 25, 26, 27, 28, 32, 35, 36, 39, 52, 55, 56, 59, 62, 63, 64, 65, 66, 67, 68, 69, 73, 74, 75, 76, 77, 78, 84, 85, 86, 87

Add a smile to the picture.



### Mystery Picture 14

**Red:** 5, 16, 24, 25, 33, 37, 44, 48, 56, 83

**Brown:** 65, 66, 75, 76, 85, 86, 95, 96

**Yellow:** 15, 17, 23, 27, 32, 35, 38, 43, 46, 55, 71, 88

**Green:** 72, 73, 74, 77, 78, 80, 81, 82, 84, 87, 89, 90, 91, 92, 93, 94, 97, 98, 99, 100

**Orange:** 6, 14, 26, 28, 34, 36, 39, 45, 47, 54, 57, 79

**Blue:** 1, 2, 3, 4, 7, 8, 9, 10, 11, 12, 13, 18, 19, 20, 21, 22, 29, 30, 31, 40, 41, 42, 49, 50, 51, 52, 53, 58, 59, 60, 61, 62, 63, 64, 67, 68, 69, 70



### Mystery Picture 15

**Yellow:** 8, 9, 10, 19, 20

**Orange:** 71, 72, 78, 81, 82, 84, 85, 87, 88, 91, 92, 95, 98, 99, 100

**Blue:** 1, 4, 5, 6, 7, 15, 16, 17, 18, 21, 23, 24, 25, 26, 27, 28, 29, 30, 31, 32, 33, 37, 38, 39, 40, 41, 42, 49, 50, 59, 60

**Green:** 44, 45, 46, 53, 54, 55, 56, 57, 58, 61, 62, 63, 64, 65, 66, 67, 68, 69, 70, 73, 74, 75, 76, 77, 79, 80, 83, 86, 89, 90, 93, 94, 96, 97

**Red triangle (pointing upwards):** 34, 35, 36, 43, 47, 48, 51, 52

Colour blue around the triangles. Add an eye and a mouth to the picture.



### Mystery Picture 16

**Black:** 44, 47

**Green:** 1, 2, 3, 4, 5, 6, 7, 8, 9, 10, 11, 12, 19, 20, 21, 30, 31, 40, 41, 50, 51, 60, 61, 70, 71, 80, 81, 84, 87, 90, 91, 94, 97, 100

**Pink:** 13, 14, 15, 16, 17, 18, 22, 23, 24, 25, 26, 27, 28, 29, 32, 35, 36, 39, 42, 45, 46, 49, 52, 53, 54, 55, 56, 57, 58, 59, 62, 63, 64, 65, 66, 67, 68, 69, 72, 73, 74, 75, 76, 77, 78, 79, 82, 83, 85, 86, 88, 89, 92, 93, 95, 96, 98, 99



### Mystery Picture 17

**Yellow:** 4 (triangle pointing upwards), 14, 24, 34, 42, 43, 44, 45, 46, 47, 48, 49, 52, 53, 54, 55, 56, 57, 58, 59, 63, 64, 65, 66, 67, 68, 74, 75, 76, 77, 85, 86

**Purple:** 7 (triangle pointing upwards), 17, 27, 37

**Blue:** 6 (triangle pointing upwards), 16, 26, 36

**Black:** 9 (triangle pointing upwards), 19, 29, 39

**Red:** 2 (triangle pointing upwards), 12, 22, 32

**Green:** 5 (triangle pointing upwards), 15, 25, 35, 62, 69, 72, 73, 78, 79, 82, 83, 84, 87, 88, 89, 92, 93, 94, 95, 96, 97, 98, 99

**Orange:** 3 (triangle pointing upwards), 13, 23, 33

**Brown:** 8 (triangle pointing upwards), 18, 28, 38



### Mystery Picture 18

**Green:** 71, 72, 74, 76, 78, 80, 81, 82, 84, 86, 88, 90, 91, 92, 93, 94, 95, 96, 97, 98, 99, 100

**Blue:** 1, 2, 3, 4, 5, 6, 7, 8, 9, 10, 16, 17, 18, 19, 26, 27, 28, 29, 50, 60, 61, 62, 70

**Yellow:** 11, 15, 23, 30, 32, 34, 36, 37, 38, 39, 40, 42, 43, 44, 46, 47, 48, 49, 56, 57, 58, 59, 63, 64, 65, 66, 67, 67, 68, 69, 73, 75, 77, 79, 83, 85, 87, 89

**Black:** 33

**Orange:** 12, 13, 14, 20, 21, 25, 31, 35, 41, 45, 51, 52, 53, 54, 55

**Black circle:** 22, 24



Josh had 6 toy trucks and was given 6 more for his birthday. How many toy trucks does he have now?



Millie was growing corn in her garden. She picked 23 cobs of corn, but 13 were rotten and had to be thrown away. How many cobs of corn did she have to eat?

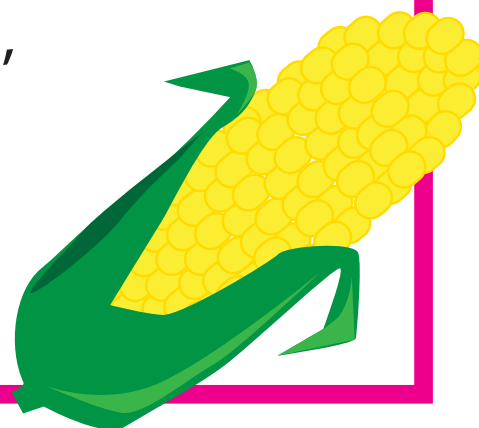

 teachstarter

Debbie was baking cupcakes for the fete. On Saturday she baked 10 cupcakes, on Sunday she baked 5 cupcakes and on Monday she baked 2 cupcakes. How many cupcakes did she bake altogether?



 teachstarter

Wendy had 16 coloured pencils in her pencil case. She gave 4 away to her friends. How many coloured pencils does she have left?



On one side of the street there are 14 houses and on the other side there are 8 houses. How many houses are in the street?



Lee has read 12 pages of her book. She still has 8 pages left to read. How many pages were in the book altogether?





You received a bunch of balloons for your birthday. There were 14 balloons but then 3 popped. How many balloons do you have left?



Dave bought a pair of shoes for \$35. How much change will he receive from \$40?



Michael saw 3 red cards, 2 blue cards and 8 white cards. How many cards did he see altogether?



In a game of cricket, Jacob scored 4 runs in the first game, 3 runs in the second game and 3 runs in the third game. How many runs did he score altogether?

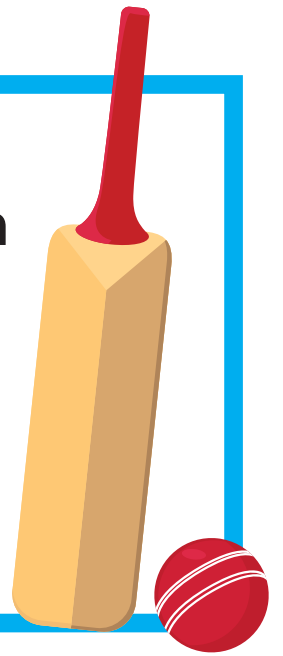

You picked 8 flowers and your friend picked 15 flowers. How many flowers do you both have when you put your flowers in a bunch together?



Alana invited 8 of her cousins and 6 of her school friends to her birthday party. How many people were invited altogether?



Cody saw 3 monkeys, 2 zebras, 12 birds and 1 elephant at the zoo. How many animals did he see altogether?



Geoff had saved \$20 and was given another \$30 for his birthday. How much money has he got altogether?



Mai bought 13 oranges on Thursday, 7 oranges on Friday and 4 oranges on Saturday. How many oranges did she buy altogether?



Peter sold 15 tickets to his family, 6 tickets to his friends and 3 tickets to his neighbours. How many tickets did he sell altogether?



teachstarter

You have 25 students in your class. 6 are away today. How many students are in your class today?

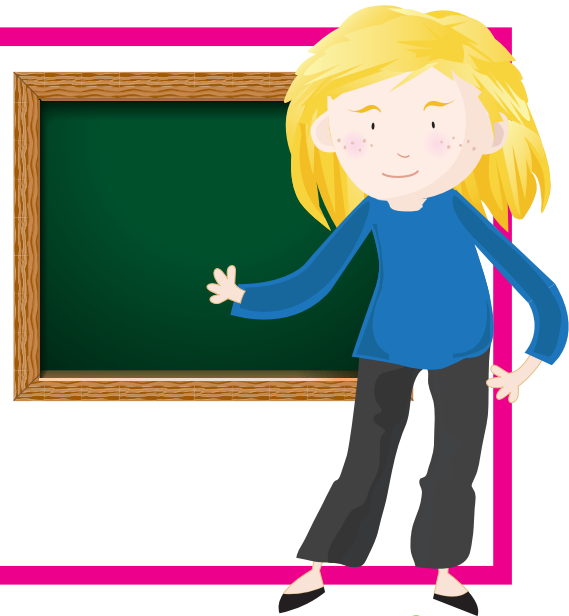

teachstarter

There were 15 lambs in one paddock, 5 lambs in another and 10 lambs in the last paddock. How many lambs are there altogether?

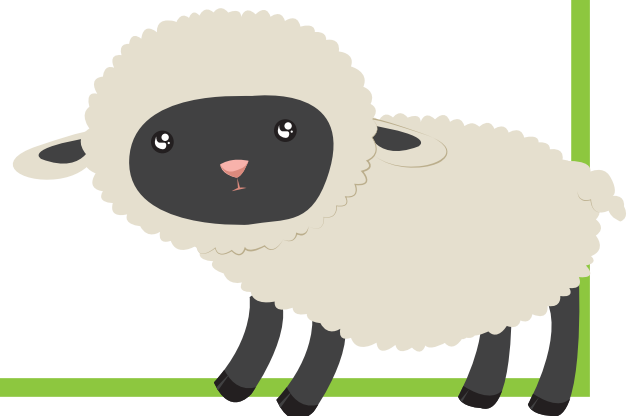

teachstarter

Serena helped to plant 35 new trees on Saturday and 14 on Sunday. How many trees did she plant altogether?



Erin's chickens laid 5 eggs on Monday, 5 eggs on Tuesday and 8 eggs on Wednesday. How many eggs did they lay altogether?





## The Scenario

Very soon, your class will be celebrating the International Day of Friendship. To help mark the occasion, your teacher is asking everyone in the class to design and make a friendship band for a special friend. You will need to use coloured, circular beads in a repeating pattern. You must use at least three colours in each design.

Your teacher would like you to create three different friendship band designs before deciding which one you like the best. You will also need to describe the pattern you have used in each design.

## The Task

**To create three friendship band designs using a repeating colour pattern.**

## The Materials

- Coloured pencils or markers
- String
- Coloured Beads

## The Procedure

1. Colour three different friendship band designs on the template provided.
2. Describe the colour pattern that you have used for each design.
3. Choose which friendship band design you like the best.
4. If the materials are available, make your design using string and coloured beads.





Name \_\_\_\_\_ Date \_\_\_\_\_

# My Friendship Band Design

## Design 1

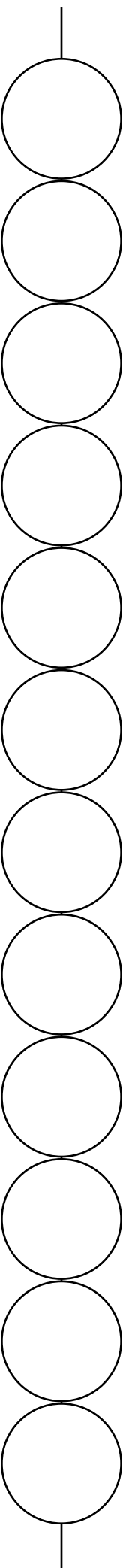

The pattern I have used for this design is : \_\_\_\_\_ .

## Design 2

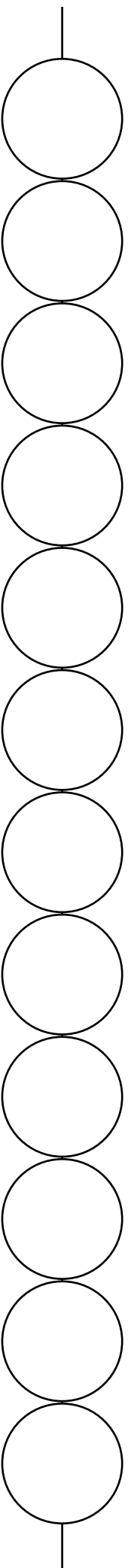

The pattern I have used for this design is : \_\_\_\_\_ .

## Design 3

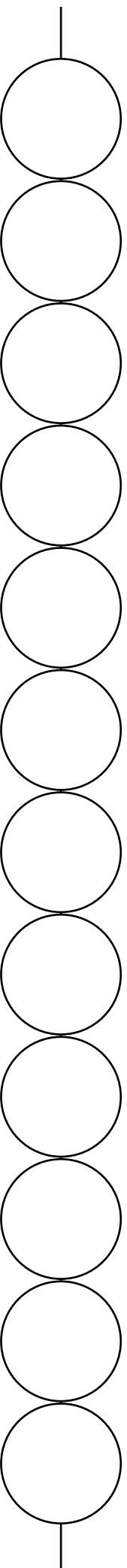

The pattern I have used for this design is : \_\_\_\_\_ .

My favourite design is number \_\_\_\_\_ because \_\_\_\_\_ .



























Name \_\_\_\_\_

Date \_\_\_\_\_

## Reflection

Shade the face to describe how you feel about how you worked during the investigation.

I listened to my teacher's instructions.			
I listened to the ideas of my classmates.			
I shared my ideas with my classmates.			
I tried to complete my work neatly.			
I tried to complete my work on time.			
I asked for my teacher's help when I needed it.			
I concentrated on the task I was doing.			
I did my best work on this task.			



# PANDORA'S PARTY PALACE

## Snacks

**\$5.00**

**Potato Chips**  
10 packets  
per pack



**\$3.00**

**Sultanas**  
6 boxes per pack



**\$6.00**

**Popcorn**  
10 packets  
per pack



## Lunch Items

**\$4.00**

**Chicken Nuggets**  
20 pieces  
per box



**\$8.00**

**Mini Pizzas**  
6 pizzas per box



**\$20.00**

**Sushi**  
20 rolls per pack



## Sweet Treats

**\$10.00**

**Chocolate Cupcakes**  
10 per box



**\$6.00**

**Yoghurt Iceblocks**  
10 per box



**\$2.00**

**Lollipops**  
Pack of 12



## Drinks

**\$6.00**

**Water**  
6 x 250 mL  
bottles



**\$10.00**

**Lemonade**  
10 x 375 mL bottles



**\$5.00**

**Juice**  
6 x 250 mL boxes



# PANDORA'S PARTY PALACE

## Decorations

**\$2.00**

**Party Hats**  
5 hats  
per pack



**\$3.00**

**Balloons**  
20 per pack



**\$1.00**

**Streamers**  
2 rolls per pack



**\$4.00**

**Bunting**  
1 x 3 m pack



**\$5.00**

**Party Poppers**  
10 per pack



**\$1.00**

**Party Blowers**  
10 per pack



## Serving Supplies

**\$2.00**

**Paper Plates**  
20 plates per pack



**\$3.00**

**Paper cups**  
25 Cups  
per pack



**\$1.00**

**Straws**  
Box of 50



**\$2.00**

**Plastic Tablecloth**  
1 per pack



**\$1.00**

**Serviettes**  
100 per pack



**\$5.00**

**Wet Hand Wipes**  
100 wipes  
per tub



## Decorations and Serving Supplies

## PANDORA'S PARTY PALACE

Lucy bought 20 sweet treats for her party.

Make a list of the sweet treats Lucy bought.



## PANDORA'S PARTY PALACE

For his pizza party, Mario bought 2 boxes of mini pizzas.

How much did Mario spend on pizza?



## PANDORA'S PARTY PALACE

Taylor's class was having an end-of-year party.

For the party, he bought 3 boxes of yoghurt ice blocks.

How much did he spend?



## PANDORA'S PARTY PALACE

Amy had some friends over for a movie night.

She bought 2 packs of popcorn to share with her friends.

How much did Amy spend on popcorn?



## PANDORA'S PARTY PALACE

Mrs Small bought some decorations for a class party.

She got 2 packs of balloons and 1 pack of streamers.

How much did Mrs Small spend on decorations for the party?



## PANDORA'S PARTY PALACE

Sam bought 5 boxes of chicken nuggets for his party.

How much did Sam spend on chicken nuggets?



## PANDORA'S PARTY PALACE

Daniel needed some paper plates for a family picnic.

If 40 people are going to the picnic, how many packs of paper plates does Daniel need to buy?



## PANDORA'S PARTY PALACE

As a special treat, Mr Wright bought his class lollipops.

If there were 24 children in the class, how many packs did he buy?



## PANDORA'S PARTY PALACE

Coach Carter bought 12 bottles of water – one for each soccer player at the gala day.

How much did Coach Carter spend on water?



## PANDORA'S PARTY PALACE

Naomi bought 2 packs of party hats for her friends to wear at her birthday party.

How many party hats did Naomi have altogether?



## PANDORA'S PARTY PALACE

Christine bought 3 boxes of cupcakes to take to school for her birthday.

How many cupcakes did Christine have to share with her friends?



## PANDORA'S PARTY PALACE

Principal Jones bought yoghurt ice blocks for each class in the school.

If he bought 12 boxes, how much did Principal Jones spend on yoghurt ice blocks?



## PANDORA'S PARTY PALACE

For a science experiment, Professor Paleo bought 4 boxes of straws.

How many straws did Professor Paleo have altogether?



## PANDORA'S PARTY PALACE

To help celebrate New Year's Eve, Lilly bought some decorations from Pandora's Party Palace. Her budget for decorations was \$20.

What could Lilly buy for \$20?



## PANDORA'S PARTY PALACE

On the weekend, Jenny had a party for her 8th birthday.

Jenny bought:

- 1 pack of balloons
- 2 packs of streamers
- 3 boxes of cupcakes.

How much did Jenny spend altogether?



## PANDORA'S PARTY PALACE

You have been given a budget of \$50 to organise your own party, using items from Pandora's Party Palace.

Make a list of the items you will buy.

Check that your items cost less than \$50.





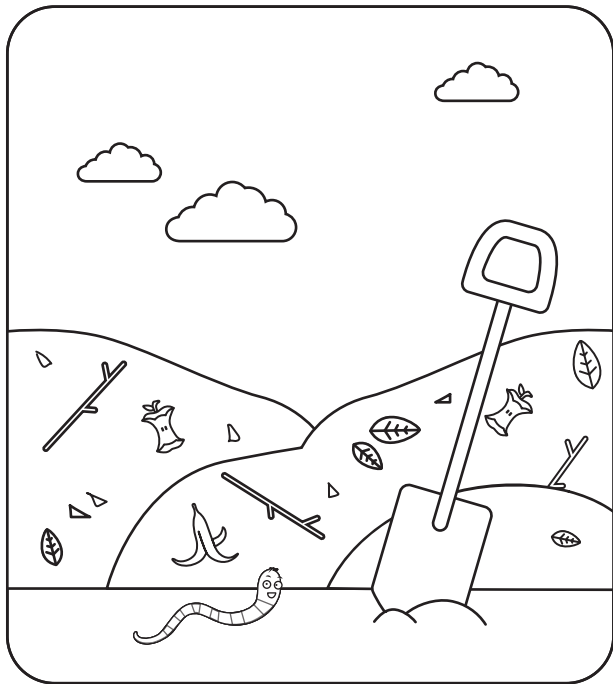

We can compost our \_\_\_\_\_ scraps.

7

# HOW CAN WE HELP — OUR PLANET? —

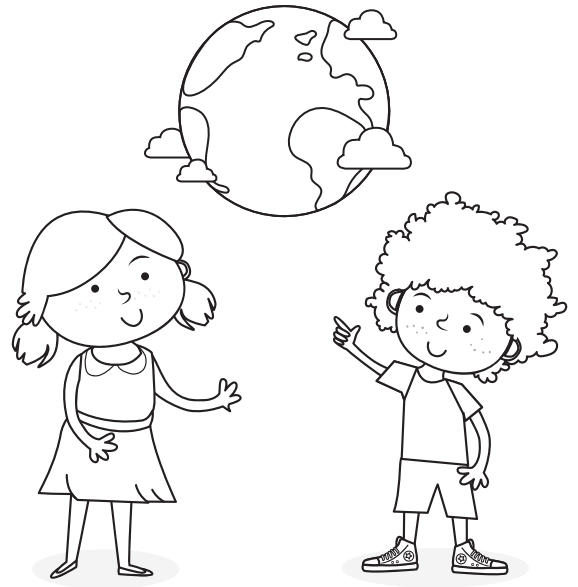

Name: \_\_\_\_\_

Teach Starter.com

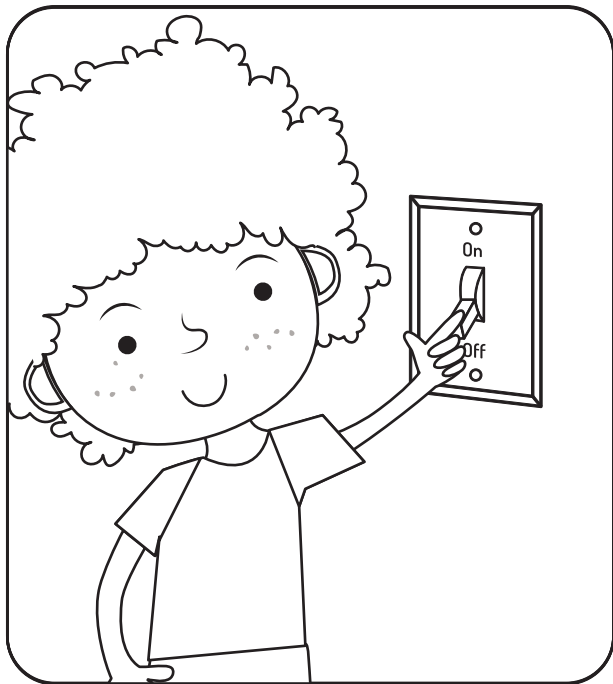

We can turn off \_\_\_\_\_ to save energy.

6



We can pick up \_\_\_\_\_.

1



We can use \_\_\_\_\_ plastic in our lunchboxes.

2



We can \_\_\_\_\_ plastic, aluminum and paper.

5

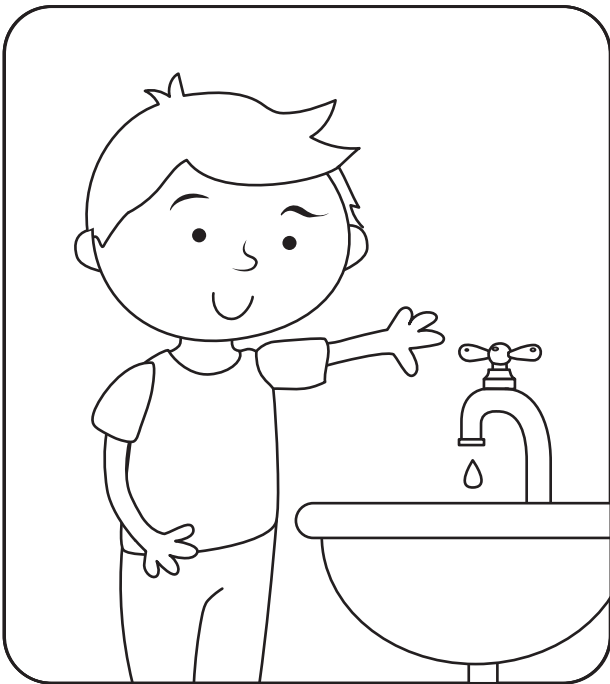

We can use less \_\_\_\_\_.

4

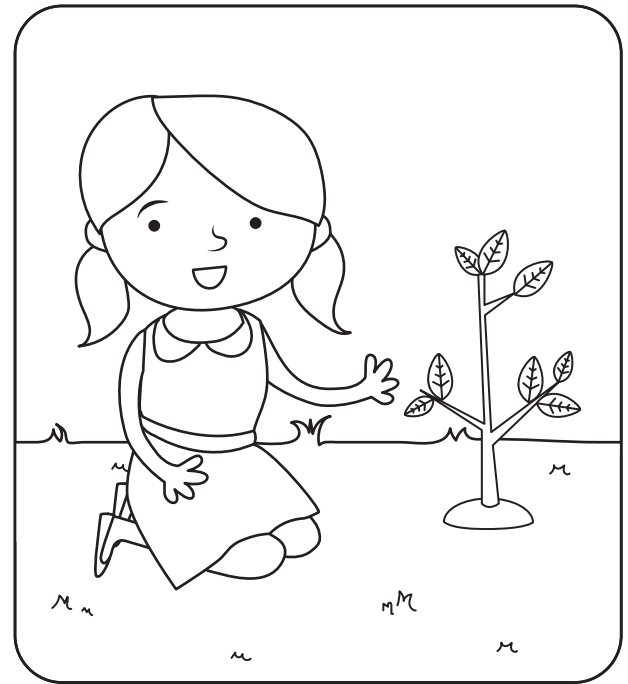

We can plant more \_\_\_\_\_.

3



# SPACECRAFT

## DESIGN TASK

### The Scenario:

Look up at the stars! An alien needs to get back to his home planet. He needs you to build him a spacecraft that will take him safely back to his home.

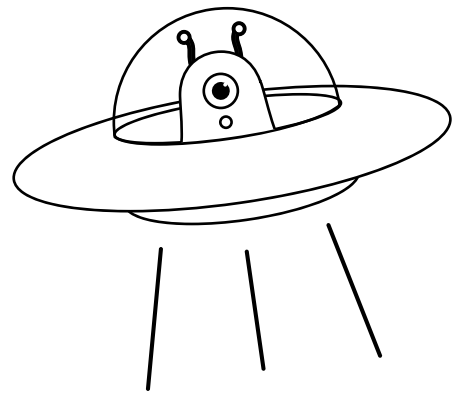

### The Process:

Follow the Engineering Design Process to help you to complete this task.

1. Ask questions - What is the problem? Are there any challenges?
2. Imagine it - Brainstorm your ideas. Pick the best one!
3. Plan it - Make a list of materials. Draw a labelled diagram.
4. Create it - Follow your plan. Create a model if possible.
5. Improve it - Did it work? Can you make it better? What could be done differently?
6. Share it - What changes need to be made? What do others think?

### Material Available:

- paper plates
- paper bowls
- paper cups
- paper straws
- pipe cleaners
- cardboard tubes
- coloured paper
- coloured card
- egg cartons
- glue
- sticky tabs
- tape
- aluminium foil

Name \_\_\_\_\_

Date \_\_\_\_\_

# Spacecraft Design Task

1. I am designing a: \_\_\_\_\_

2. I will need the following materials:

- 
- 
- 
- 
- 
- 
- 
- 

## Labelled Diagram of My Spacecraft



